



English Manual

Pro Batt Waterproof

USERS MANUAL.

For most up to date user manual please refer to this QR code. Instructions are constantly being updated.

STERLING POWER

IP68 Rated

IP55 rated fan (replaceable)

If the fan needs replacing - please go to our website - **BBWF** is the part number. It is a ~2W 40mm fan with appropriate DC connectors.



BBW

Waterproof Battery to Battery Charger

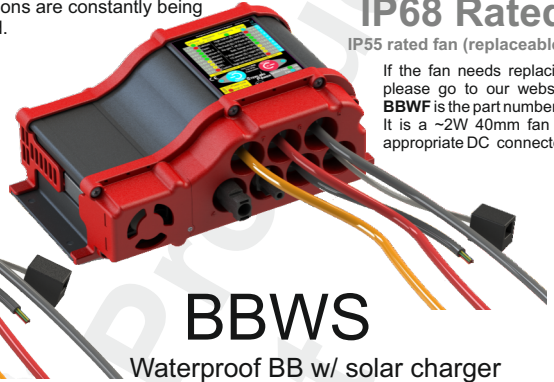

BBWS

Waterproof BB w/ solar charger



Test Report Sheet

Each product gets uniquely tested and a report is generated. This unique test report is present inside this box. You must keep this test sheet in this box and keep this box safe. This sheet should be present when the charger is being warranted.



battery temp sensor TSAY



Optional Remote Instructions inside **BBURC**

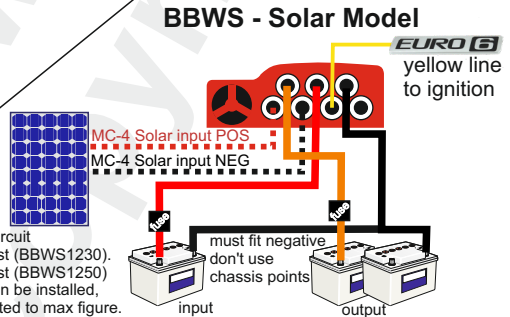
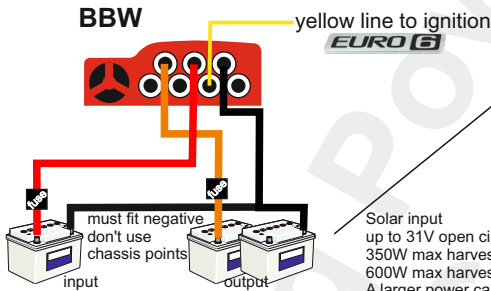

MUST READ

For the majority of users, reading this paragraph should be sufficient for installation. The unit can be installed by simply connecting it between an input and output battery, as depicted. **The solar panel's positive and negative connectors go to the +ve and -ve MC4 connectors provided (BBWS models only) - voltage should not exceed 31V (12V panel).** The BBWs, by default, shall start charging when the starter input voltage exceeds 13.5V and switches off when the voltage drops below 13.3V (all models). The default charging profile is 14.4V abs. and 13.6V float - **for sealed lead acid batteries** (x2 for 24V | x3 for 36V | x4 for 48V). This means that the vast amount of installations can be fitted out of the box without any adjustments. In certain circumstances, when installing in a Euro 6 vehicle, we recommend using an ignition feed to the unit. When the ignition is live, unit starts charging (may take up to 60 seconds). Please read the manual for additional information. If in doubt, and installing on a New Euro 6+, use ignition feed. For info on BMS, remote sense, temp sensors and remote control, please consult the manual. Solar charge shall operate when engine off and predominately go to the leisure battery. For the BBWS1230 the maximum wattage that can be harvested from the solar panels is 350W - 31V maximum and 16A maximum. The larger BBWS1250 can harvest up to 650W.

Copyright © 2021 Sterling Power
AUGUST 2021 V1



RoHS compliant



Contents Page

Legal and Safety Information	Page 3	First time use	Page 10
How to use the instructions		Changing battery profile type	
Copyright and Plagiarism		First and second LED column meter readings	
Maintenance and Repair		Guide to the 2 buttons	Page 11
Safety and Precautions		Simplified chart corresponding to button use	
Front Panel Display I	Page 4	FACTORY RESET	
Front Label display annotated		Force Option feature explanation	Page 12-13
What the LEDs mean		Detailed description of button / force functions	
BBW Cable information	Page 5	Custom Settings	Page 14-15
Power cable cluster		How to set a custom charge profile	
Auxiliary control cable		Adjusting bulk / absorption / float / times	
Other relevant cables		Adjusting operation on / off voltages	
Installation Diagram (non Solar)	Page 6	Remote Control Operations	Page 16
wiring diagram for installation		Comprehensive breakdown of remote functions	
Installation SOLAR BBWS	Page 7	Troubleshoot understanding panel LEDs	Page 17
wiring diagram for installation		Fault Finding	Page 18
Lithium Battery Installation	Page 8	Fundamental fault + troubleshooting	
Lithium Battery Charging Profiles		LED displays w/ meanings and solutions	
External and Internal BMS shutdowns		Sterling's Warranty Statement	Page 19
0 Deg C temperature sensor trip		Customer service and warranty declaration	
Automatic Ignition Feed Modes	Page 9		
Automatic activation (non ignition mode)			
2x Ignition feed modes EURO 6			

Cutting of the pre-wired / pre-fused cable shall void warranty.

Product Specifications

	BBW1230	BBW122430	BBW123630	BBW124830	BBW242415	BBW241215	BBW244815	BBWS1230
Input Voltage (V DC)	11 - 20	11 - 20	11 - 20	11 - 20	22 - 40	22 - 40	22 - 40	11 - 20
Output Voltage (V DC)	12V	24V	36V	48V	24V	12V	48V	12V
Solar input voltage (V DC)	N/A	N/A	N/A	N/A	N/A	N/A	N/A	≤31V
Max Solar Harvest	N/A	N/A	N/A	N/A	N/A	N/A	N/A	≤350W
Input Current (A)	30	30	30	30	15	15	15	30
Battery types (all models)	AGM GEL SEALED OPEN LiFePO ₄ (2) CALCIUM CUSTOM							
IP rating	IP68	IP68	IP68	IP68	IP68	IP68	IP68	IP68
Ignition Protected	Yes	Yes	Yes	Yes	Yes	Yes	Yes	Yes
Quiescent Current (mA)	1	1	1	1	1	1	1	1
Battery Connector	1.5m cable / Pre-wired / Pre-fused / 8mm ring terminal							
Weight (Kg)	4	4	4	4	4	4	4	4
Dimensions (LxWxD) mm	141 x 238 x 90							

	BBW1250	BBW122450	BBW123650	BBW124850	BBW242425	BBW241225	BBW244825	BBWS1250
Input Voltage (V DC)	11 - 20	11 - 20	11 - 20	11 - 20	22 - 40	22 - 40	22 - 40	11 - 20
Output Voltage (V DC)	12V	24V	36V	48V	24V	12V	48V	12V
Solar input voltage (V DC)	N/A	N/A	N/A	N/A	N/A	N/A	N/A	≤31V
Input Current (A)	50	50	50	50	25	25	25	≤600W
Battery types (all models)	AGM GEL SEALED OPEN LiFePO ₄ (2) CALCIUM CUSTOM							
IP rating	IP68	IP68	IP68	IP68	IP68	IP68	IP68	IP68
Ignition Protected	Yes	Yes	Yes	Yes	Yes	Yes	Yes	Yes
Quiescent Current (mA)	1	1	1	1	1	1	1	1
Battery Connector	1.5m cable / Pre-wired / Pre-fused / 8mm ring terminals							
Weight (Kg)	6	6	6	6	6	6	6	6
Dimensions (LxWxD) mm	176 x 238 x 90							

These values may change, we are constantly updating our instruction manual and product line. Please refer to our website for the latest information.

▸ Legal and Safety

Using the Instruction Manual

This manual must be read throughout before installing this electronic device. Do not lose these instructions - keep them safe. The most up to date instructions can be found on the Sterling Power website. Please refer to the latest instruction manual before contacting Sterling. At Sterling, we endeavour to include all of the product information that we can think of into the manual.

Installation of the electronic device must be carried out by a qualified and trained personnel only. The personnel must be familiar with the locally accepted guidelines and safety measures.

Sterling Power's warranty statement

A comprehensive warranty statement is provide at the back of the instruction manual. A comprehensive warranty statement can also be found on sterling-power.com.

Copyright and plagiarism

Copyright © 2020 Sterling Power. All rights reserved. Reproduction, transfer, distribution or storage of part or all of the contents of this document is strictly prohibited. If you wish to use all of this document, or excerpts from it, Sterling Power must be contacted.

Liability

Sterling Power can not accept liability for:

- consequential damage due to use of this device
- possible errors in the manuals and the results thereof

Device modification

Please do not modify the device unless you have been instructed to do so by Sterling Power, directly. Product modification shall be done at Sterling, when needed. Warranty shall be voided if personal attempts are made to modify the device, without Sterling's approval.

Use the battery to battery charger only:

- For DC to DC conversion.
- For DC current limiting.
- With fuses protecting the DC cables.
- In a well ventilated, dry, dust-free and condensation free environment.
- When instruction manual has been read through.

Safety Symbols



CAUTION
WARNING



EXPLOSION

- **Example - WARNING.** Never use the device in situations where there is danger of gas / dust EXPLOSION or potentially flammable products.

General maintenance and repair

The device must be switched off during maintenance. It must also be protected against unexpected switching off. Remove battery connections and ensure unit is off. If repair is required, only use original parts.

General safety and installation precautions

- Install device in well ventilated space. Do not expose device to: Rain, snow, spray, moisture, pollution, condensation. Do not cover or obstruct ventilation openings.
- Device connects to common negative. Common negative must be earthed.
- In case of fire use a fire extinguisher.
- Ensure reverse polarity and short circuiting is avoided - to prevent damage to battery.
- Protect DC wires with the appropriate sized fuse.
- Check cabling annually- fix where needed.
- Avoid contact with device with damp hands.
- Ensure the device is adequately and securely mounted to prevent the unit from displacement.
- Use a professional to install device.

Battery safety

Excessive charge or discharge and high voltages can cause serious damage to batteries. Never exceed the recommended limits. If battery acid contacts skin or clothing, wash immediately with soap and water. If acid enters the eye(s), immediately flood the eye(s) with running cold water for 20 minutes and seek medical attention.

Give extra care to not drop metal tools or jewellery on to the battery terminals as short circuiting can take place. Refrain from charging battery up to 4 hours prior of installation to avoid the formation of explosive gases.

Never smoke / generate a spark around batteries.

Cutting of the pre-wired / pre-fused cable shall void warranty.

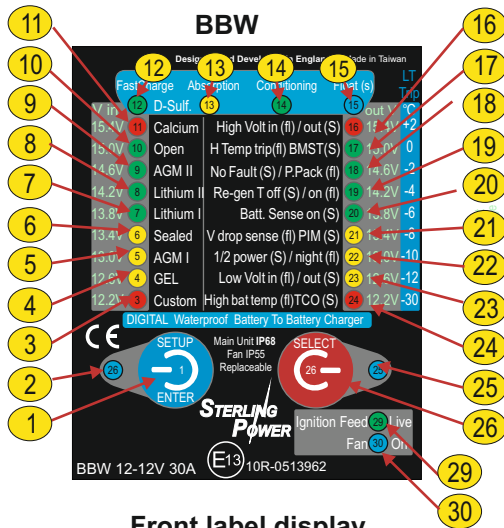

Front label display

- 1 & 26) ENTER / SETUP and SELECT buttons, used to adjust settings.
- 2 & 25) Background light for button, used also to show unit is operational.
- 3)-11) The first column of LEDs have 3 different functions. Firstly, on unit start up the battery type is displayed. Secondly, after startup it becomes an input voltmeter. Thirdly, during custom setting the voltage scale is used to set the voltage - refer to later.
- 12) This LED has 2 meanings. Firstly, when on battery type selection mode this is the Desulphation setting indicator. Secondly, on default mode (most times) this shows the charger is on fast charge mode.
- 13-15) These LEDs show the battery charge progression through its cycle.
- 15) Flash when in asleep.
- 16-24) Has 3 functions: Firstly, during operation they show the output voltage. Secondly, if an alarm is present the alarm shows up. Thirdly, this row is used in the custom setup procedure to set timing functions, voltages and time factors. Its general function is as an output voltmeter, in the event 2 LEDs are on the voltages is between the 2 settings, if the top or bottom red LED is on then the voltage is outside the parameters of the voltmeter.
- 16) High voltage, if on solid it is high output voltage, if flashing it is high input voltage.
- 17) High temp trip, if flashing then high unit temperature trip.

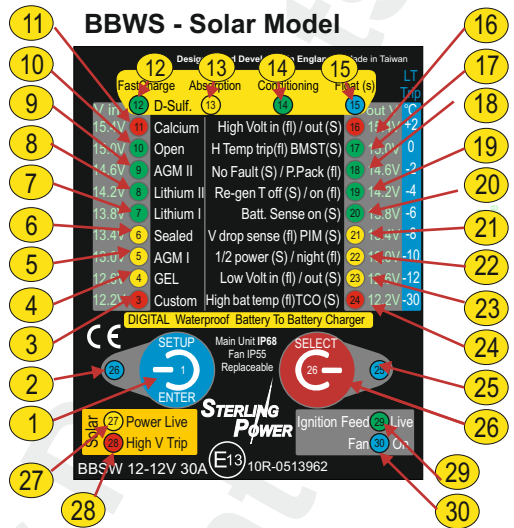

- 18) No faults (solid on). Power Pack mode / live voltage output (flashing).
- 19) No regen. mode or regen. timer at 0 = solid LED. Regen on / timer on = flashing LED.
- 20) Remote Battery sense cable connected (solid).
- 21) Battery sense voltage drop in cable outside the prescribed 1.5V drop maximum, thicker cable required - LED flashing. PIM = Pure Ignition feed mode - if this LED is on solid during status, then the unit is set to operate only if ignition feed is live.
- 22) Device's power ability reduced due to high ambient temperature or voltage drop in output cable too large. Alarm will be in conjunction with other information alarm. If flashing, unit is in night mode with reduced power and lower fan speed.
- 23) Low voltage alarm, low voltage on input = flashing LED. Input alternator not supplying enough power or failed. Low voltage output = solid LED. Something consuming a lot of power or unit not working. No voltage output then LED on solid.
- 24) If flashing then battery temperature too high. TCO Temperature Compensation Off LED means that when illuminated the temp comp is off.
- 27) Solar power live LED comes on when the solar is active. this also means that the voltmeter LEDs voltage legend changes to the yellow / solar voltage input. **BBWS Solar only.**
- 28) If solar voltage exceeds 32V the red LED comes on + unit stops. **BBWS solar only.**
- 29) Ignition feed LED - if ignition feed is connected AND live, this LED shall come on.
- 30) Fan on



Optional Remote Instructions inside BBURC

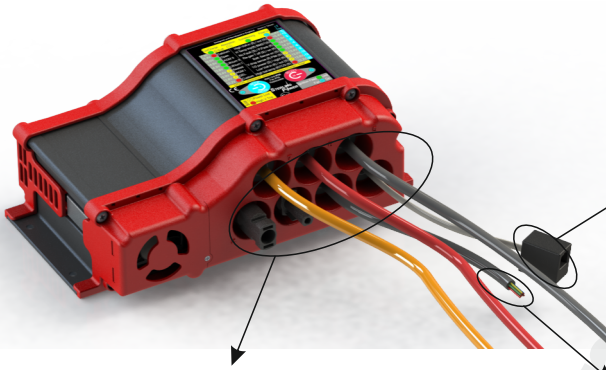

Remote Port

The BBURC comes with 10m of cable. This cable can be connected directly to this RJ connector port (circled) coming out of the BBW. The remote control features appear towards the back of this instruction manual.

Power Cable Cluster

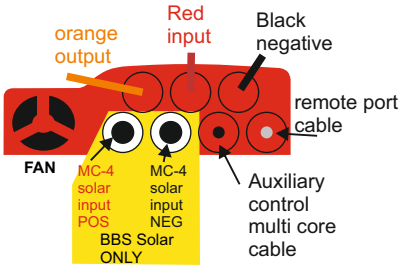

Auxiliary control cable

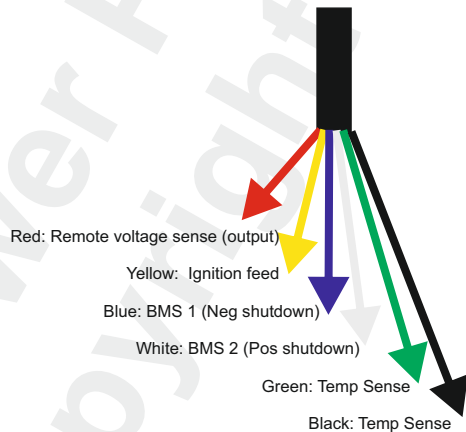

DC power cable ratings and fuses

We fit cable that is appropriate for the amperage going through it and the length of the run (1.5m in and 1.5m out). We then rate the fuses in the fuse holder based on the cable rating. Fuse ratings and cable thicknesses shall vary depending on which BBW model has been chosen. **Cutting the cables shall void warranty.** It is okay to extend the cable from the point of the ring terminal onwards. Negative cable between input and output battery, is supplied (2m).

Remote voltage sense (optional fit)

This red cable you would extend and connect on to the positive terminal of the output battery (the battery you wish to charge up). This provides feedback to the BBW as to what the appropriate charge voltage should be to compensate for voltage drop across potentially long or poor cabling. It shall provide more accurate charging performance.

Ignition Feed (must have for Euro 6 install)

This yellow cable is the signal feed or ignition feed cable. A live voltage applied to this cable shall tell the unit to turn on an begin charging. Do not connect this directly to a battery but via a switchable live feed - preferably an ignition style switch. With Euro 6 vehicles you can not rely on automatic voltage activation on the input battery to turn the BBW on. Thus a signal / ignition feed is a must have install.

battery temp sensor TSAY



Temperature sensor (optional)

The green and black cables are to be connected to the TSAY - temperature sensor. This TSAY should be provided with the BBW. The polarity of these cables do not matter. Run the TSAY ring terminal to the negative terminal of the output battery. By adding the TSAY you shall be providing battery temperature readings to the BBW and the BBW shall modify the output voltage accordingly. 20DegC is the zeroed point. Every 1DegC above this the charge voltage shall drop by 18mV. Every 1DegC below this the voltage shall climb by 18mV. If battery temp hits 50DegC, BBW trips and displays a fault.

For BMS features, see Page 8

Full Installation Diagram / all non Solar Models

Please ensure you have the correct input and output voltage BBW model to complement your DC system. Connecting a higher voltage battery to the inappropriate BBW shall result in irrecoverable damage. For example, DO NOT connect a BBW1230 to a 24V battery..



BBWRC
(optional product)
(optional fit)
10m cable
54mm hole

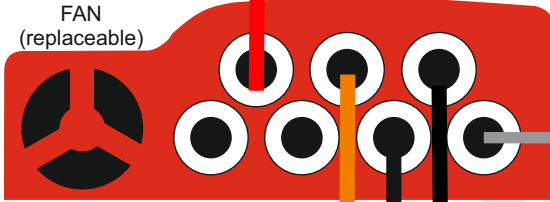

If the fan needs replacing - please go to our website - **BBWF** is the part number.
It is a ~2W 40mm fan with appropriate DC connectors.

Neg. cable can be either installed on input or output battery's negative. Also, Negative cable between input and output battery must be connected (not provided).

Important NEGATIVES
should all be common.
DON'T USE CHASSIS
We recommend joining the BB's neg. using cable direct to the starter battery negative.
For improved efficiency.

Cutting of the pre-wired / pre-fused cable shall void warranty.

input battery cable (pos)



BMS 1 + 2
(explanation overleaf)

Remote sense, connect to positive terminal of output battery. (Optional fit)

must fit negative

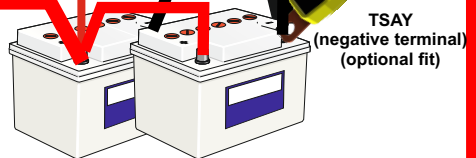
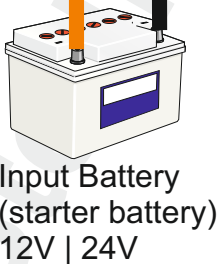

Output Battery
(House / Bow T. / Trolling etc.)
12V | 24V | 36V | 48V

output battery cable (pos)

fuse

fuse

TSAY (negative terminal) (optional fit)

Full Installation Diagram for Solar Models

Please ensure you have the correct input and output voltage BBW model to complement your DC system. Connecting a higher voltage battery to the inappropriate BBW shall result in irrecoverable damage. For example, DO NOT connect a BBW1230 to a 24V battery..

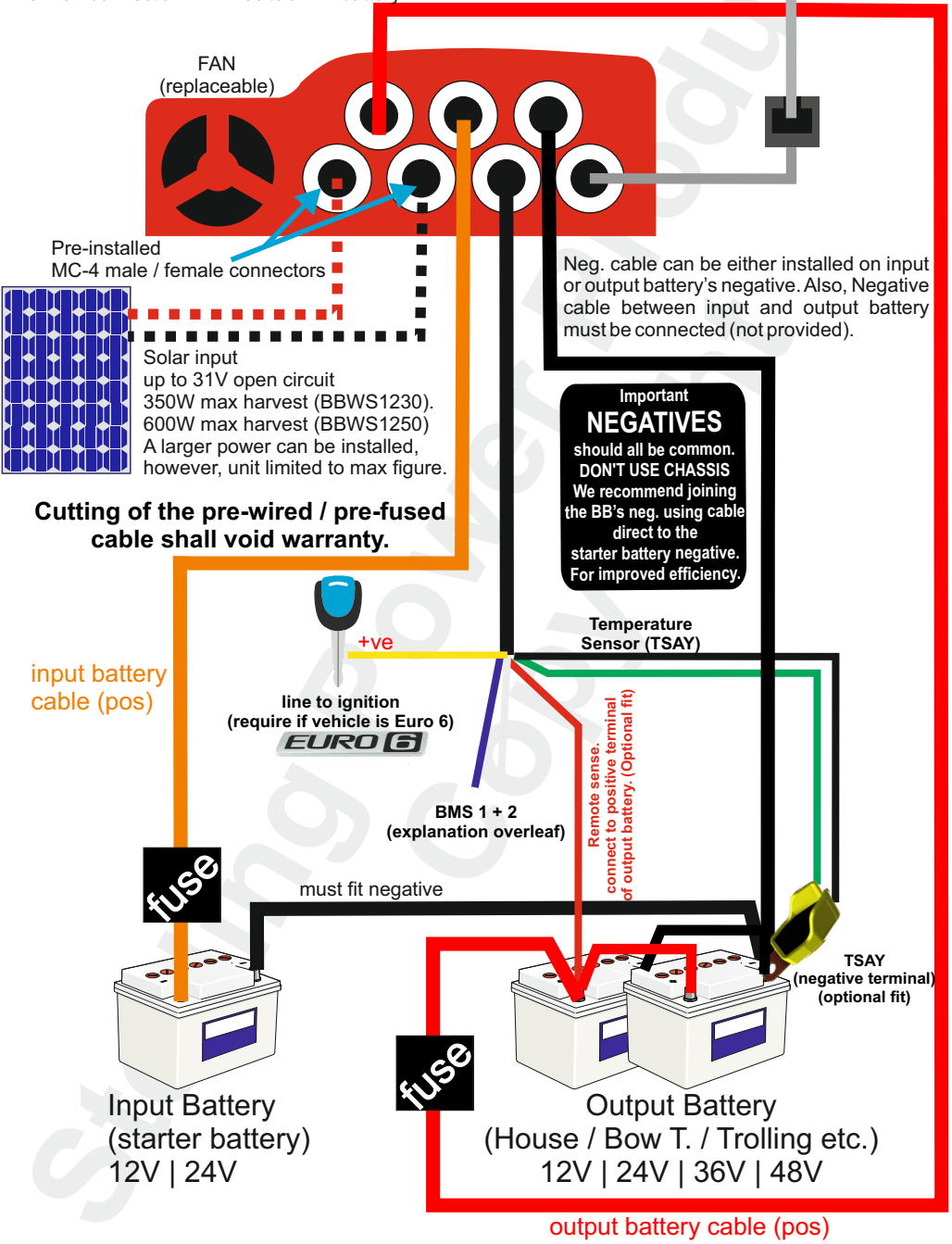

This page is unique to those installing lithium batteries as a domestic battery bank. This page assumes that you have a lead acid style starter battery and a domestic lithium battery bank that is within the C rating of the battery to battery charger that you have chosen. Typically, an individual 100Ah lithium battery has a 0.5C maximum charge current (~50A) and a 1C discharge current (100A) - these current figures double, triple by parallelling 2x, 3x etc.. lithium batteries together. Please consult your lithium battery documentation to ensure that the BB selection is suitable for your lithium battery and within about 70-80% of the rating of your alternator (or lower) - to increase lifespan of your alternator. The BB shall operate with an internal or external BMS. A BMS is a must have when charging lithium batteries. If this paragraph means little to nothing to you we would consult advise before proceeding.

› Changing battery type

We provide 2 lithium profile presets. Lithium I is 14.2V charge and 13.8V float. Lithium II is 14.4V charge and 13.8V float. These can be selected in the normal battery type selection process. By putting the BB into either of these modes immediately removes the reverse polarity protection and put the BB into 'power supply mode'. If you wish to customise your charge profile proceed through the custom route, however, please change the power supply mode to on in the settings.

› External BMS shutdown

Certain lithium batteries shall have an external battery management system. Particularly if the bank is large or contains multiple batteries and/or in sophisticated setups. External BMS generally do a better job of managing multiple lithium batteries within a large bank. These external BMSs give out either a positive signal or ground signal when they wish to tell the charger to stop charging (trip signal). The BMS 1 and BMS 2 cables on the BBW are the connectors that the external BMS's signal shall feed into. Make sure you select the correct port.

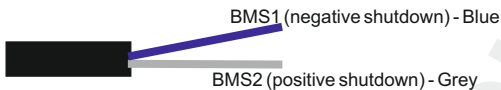

Use either the blue or grey cable to connect to the particular signal. A trip shall result in the BBW stopping charge. Charge shall resume upon removal of this signal.

Use BMS 1 - if your BMS trips and provides a 0V (ground signal), then use BMS 1. This shall result in the BBC turning off. Once the BMS removes this trip status, i.e. the 0V signal goes back to a +ve signal, the BBC shall start charging again.

Use BMS 2 - if your BMS trips to a +ve voltage (2V-17V), then use BMS 2. This shall result in the BBC turning off when this voltage is received. Once the BMS removes this trip status, i.e. the +ve signal goes back to 0V signal, the BBC shall start charging again.

OR

Remote trip - the BMS connectors can also be used as a basic remote trip. Simply apply the correct trip signal voltage to the relevant BMS connector for the desired effect. For example, if you never want the BBW to charge when you have some ancillary equipment or alternative battery charger operating, then you can simply feed the required signal into either 1 or 2.

› Internal BMS shutdown

Drop in style, off the shelf, lithium batteries tend to have an internal BMS that looks after that specific battery. The parameters of that BMS shall trip and engage when the BMS deems the environment either hostile or acceptable to accept charge. There is no back-feed mechanism to the BBW required here as the BMS itself trips the battery internally. Some specifications of these BMS require the BBW to not provide any charge at low temperature 0 DegC or below. Please read below.

› 0 Deg C trip

If you want the BBW to stop charging when your lithium battery is at 0Deg C then please read here.

Firstly, connect the temperature sensor (TSAY) that is supplied with the device to the negative terminal of the lithium battery bank and then connect the other end (two wires) to the appropriate connector on the BBW - normal temp sensor installation.

Secondly, set the BBW to lithium battery type (I or II) - using the normal 'battery type setup'. Once you have selected either lithium battery Preset I 14.2V (x2 for 24V etc) or lithium battery Preset II (x2 for 24V etc). By selecting either of these presets and by putting on the temperature sensor the BB now defaults to 0 Deg C trip.

If you want a different temperature trip then you must go through the custom charge profiles as appears on page 15.

If you do not want this feature at all, please remove the temperature sensor from the connector on the BBW. This shall immediately engage the BB to charge. As there is no temp sensor now connected there shall be no tripping based on battery temperature.



After custom charging profiles have been set, the last option in the custom procedure is to set temperature trip. The default, as it assumes lead acid, is -30 Deg C, so the RED LED at the bottom shall illuminate. For lithium, bring this LED up to your desired trip temperature. E.g 0, -2, -4 Deg C etc.

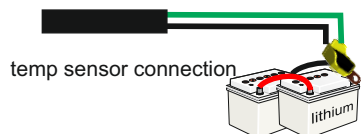

Please refer to the installation diagrams on pages 6 and 7 for installation instructions.

Automatic Activation

Automatic activation (default setting) - no ignition feed required. This means that the battery to battery charger operates based on sensing voltages at the input battery connector. **No ignition feed.** When the input voltage exceeds 13.5V-19.0V (x2 for 24V) then the unit will simply start charging. If the voltage drops below 13.3V the unit shall turn off. With a caveat, read on.

However, if the input voltage has exceeded 13.5V (2x for 24V) for 5 seconds the regen. braking timer is prepped and shall become active if the input voltage drops down to 12.0V-13.3V. This timer is 240s (default - can be changed) and allows the charger to continue charging at these lower input voltages. If the voltage drops below 11.9V the charger goes to sleep irrespective of the timer. If the input voltage remains between 11.9V-13.0V for over 240s the charger also goes to sleep. To wake the charger, the input voltage needs to rise above 13.2V - this shall also reset the regen. braking timer. These parameters can be modified.

2x Ignition feed modes

when the BBW receives an ignition feed signal the regen. braking timer = 0 seconds



EURO 6

Ignition mode 1 (default when ignition feed is applied) allows the user to operate the BBW based on the automatic activation voltage parameters, as above, whilst also having control of the BBW using the ignition signal. If your vehicle's alternator is putting out a voltage below that of 13V (26V for 24V) the live ignition feed signal shall still operate the BB W(10V+). Whereas, in the mode above the BBW shall turn off when the voltage drops below 13.0V or may never even turn on if this voltage is never met. This is why we recommend installing an ignition feed for Euro 6 vehicles. The BBW shall turn off only when the input voltage drops below 13.0V AND the ignition feed switches off. The possible downside of this mode is that the BBW shall work even when the ignition feed is not applied - provided the input voltage is above 13V (x2 for 24V). This may be sub optimal if you wish for your BBW to remain off when the vehicle is parked up and you have alternative charging sources onto your DC system. However, this mode may be what you wish for precisely that reason. If you want a more classic binary on/off ignition mode - please see ignition feed mode 2 below. **Mode 1 is default, once live ignition is applied.**

EURO 6

Ignition feed mode 2 (Pure ignition). This mode is slightly different to mode 1. If, you want the BBW to simply be on/off based purely on ignition then you shall want to use this mode. For example, if the only time you ever want the BBW to work is when you're driving (ignition live) then this is ideal. It shall not operate based on the DC voltage at the input terminal. If you have a live ignition the BBW shall turn on, when the ignition is off the BBW shall stop charging. Simple on/off. There are no voltage parameters at the DC input terminal that need to be met here, simply 10V+ (2x for 24V). To put it in this mode, apply an ignition feed cable to the 'Ignition' terminal on the connector block, as above. ALSO, you shall need to turn on 'pure ignition feed' mode by holding down SETUP button for 20 flashes and letting go. The unit shall now ONLY operate when there is a live ignition feed - if the BB is wired up without an ignition the unit shall simply not function. This shall limit the unit's flexibility. However, this mode shall be ideal for those that have alternative chargers (solar / wind) or auxiliary chargers who wish for the BBW to be OFF when vehicle is parked up. Apply a factory reset if you wish to restore default settings.

WARNING: If ignition on the vehicle is left ON and the engine is OFF, you shall deplete your starter battery down to 10V. Also, if your alternator is less than 60A or can not produce 60A at idle revs you may discharge your starter battery. To partial get round this problem we reduce the performance of the BBW at lower input voltage.

With any of these modes selected, the BBW may take up to 60 seconds to turn on. This is due to the BB being asleep, when not in use. This preserves battery life. It brings the quiescent current down to 1mA.

On first start up all LEDs will light up. A beep should sound. The fan shall then start running for around 5 seconds. If, after this, 2 red LEDs flash for 8 seconds you may have a calibration issue and the unit should be returned to Sterling. If 2 solid red LEDs are on at the top or bottom then you either have high or low input voltage (respectively) - check your voltages.

Changing charging profile during startup

After the initial start up an LED on the first column shall light up for 5 seconds, this shall indicate the battery type selected - **default is 'Sealed' lead acid**. This is your window of opportunity to change the charging profile. If you have missed the opportunity, you can wait for the unit to go in to normal operation and follow the instructions immediately below.

Preset Battery Options					
Options	Bulk / Abs. Volts	Cond. Volts	Float Volts	Min Mins	Abs. Max Mins
1) Gel	14.00	13.80	13.70	600	1440
2) AGM I	14.10	13.75	13.40	60	480
3) Sealed	14.40	14.15	13.60	120	480
4) Lithium I	14.20	13.60	13.60	30	30
5) Lithium II	14.40	13.80	13.80	30	30
6) AGM II	14.60	14.10	13.70	60	480
7) Open	14.80	14.00	13.30	60	480
8) Calcium	15.10	14.30	13.60	60	360
9) Desulphation	15.50	-----	-----	240	240
10) Custom	Custom Charging Profile				

If battery temperature sensor is connected then all voltages are based on 20 Deg C. If sensor senses less than 20DegC = increased voltage. Higher than 20DegC = decrease voltage. The further from 20DegC in either direction leads to proportional increase or decrease in the voltage. (x2for24V/x3for36V/x4for48V)

Left and right meter readings.

During normal operation

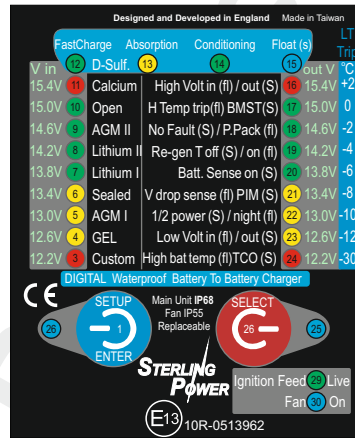

Out of range voltage values

If voltage exceeds the meter's range the upper right LED shall flash. If the voltage falls short of the meter's range the lower LED shall flash. If two neighbouring LEDs, on the voltmeter, are on simultaneously then the real voltage is between these two parameters. Example, if LEDs at 14.6V and 14.2V were on then the approximate voltage shall be ~14.4V.

Low or high output voltages

If the output voltage is below 1V (2V at 24V) or reverse polarity then the low output voltage LED will flash (number 23). Similarly, if the output voltage is above 15.5V (31.0V at 24V) the high voltage LED shall flash (number 16). To resurrect these problems, bring the voltage above 1V on the output and below 15.5V, correct the polarity and then restart the device.

Return to factory default: This shall irreversibly erase all previously entered settings. Press and hold both buttons for 8+ flashes and let go. 3 green LEDs on both columns shall flash. The unit should then reboot with the default settings.

To view charger's status:

Simply hold the SELECT button for 1 second and the right LED should flash indicating the status of the charger. This shall flash for 8 seconds. To return quickly, press the SETUP/ENTER button once.

***Lithium profiles have reverse polarity protection disabled. **All voltages shall be 0.1V higher for the first 3 minutes of the chargers operation.**

If either lithium settings are selected AND the temperature sensor is connected to the negative terminal of the lithium battery, the BB shall trip at ≤0Deg at the sensor. This can be adjusted in custom profile, or simply remove temp sensor.

Remember it is the voltages that are more important than our battery types. After installation, test the voltage from the BB is the desired voltage. **Ensure you remove at least 1 wire from the battery temperature sensor as the product voltage may be higher (if in cold climate) or lower (if in warm climate) than the preconceived voltage.** The voltage requirements of the battery company will override our recommendations as it is them who are supporting the battery warranty.

Changing charging profile during operation.

While the unit is running, hold down SETUP button for 10 flashes. All LEDs on the first column shall now flash. By using both buttons toggle through the various profiles (see below). The right button is up the column and the left button takes you down the column. The LED shall light up demonstrating which profile you have selected. When the LED has illuminated at your desired profile simply hold both buttons for a couple of seconds or simply just leave the charger alone for 30 seconds and it will set the desired profile. The corresponding LED shall flash to confirm. The unit shall then restart and go through the starting cycle again in this new charging profile.

If BBW is in sleep mode, either buttons can be pressed to wake the BBW up. The BBW needs to be on (lit up) for any of these buttons to operate



# flashes	Setup only button
0-1	Silence Buzzer / Status display / Change to voltage display
5	Software version
10	Select battery type
15	Power supply mode / live output voltage
20	Pure ignition feed mode
25	Change operational on/off voltage
30	Set auto regen. braking timer
35	Temperature voltage compensation
40	Buzzer off (long term)
45	Maintenance Mode

# flashes	Select only button
0-1	Silence Buzzer / Status display / Change to voltage display
5	Display temperature
10	Force to float
15	Night Mode
20	1/2 Power Mode
25	Standby
30	Turn unit off / on again
40	OEM Lock
45	Solar Charger on*/off
50	BB Charger on*/off

BBWS solar only



1x blue LED flash = 1 second

For a more detailed description of these options please look at the next 2 pages

▸ **Factory Reset**

To restore the BB to default settings simply press and hold both buttons together for between 8-35 flashes and let go. This shall restore the BB to factory default settings. To confirm a successful reset, 6x Green LEDs shall flash.

A factory reset may be worth doing if your BB is behaving incorrectly after having made adjustments to it, as it allows your start again.

# flashes	Both buttons
8 - 35	Factory Reset



Silence Buzzer quick press

If the buzzer is sounding and you wish to silence it, simply press SETUP button with a quick but firm press. This should silence the buzzer. It is a short term feature. If you wish to turn the buzzer off forever, please press the SETUP button down for 40 flashes.

to view the status of the charger - do a quick press.

to view the BB as a voltmeter - do a quick press.

Software version 5 flashes

If you are interested in the software version of your BB, press and hold the SETUP button down for 5 flashes. The display is in binary format.

Battery type select 10 flashes

Please consult page 10 regarding changing battery type. Also, for custom battery type please consult page 14.

Force unit to output live charge voltage without output battery connected (i.e. as a power pack / live output) - (default off) 15 flashes

This mode shall allow the unit to operate without needing a voltage on the output terminal. Hold down the SETUP button for 15 flashes and let go. A charge voltage shall now be applied to the output terminal - irrespective of whether there is a battery there. Press SETUP for 15 flashes then let go.

Pure ignition feed mode (default off) 20 flashes

Pure ignition feed mode, if this mode is enabled the BB shall ONLY operate if there is an ignition feed. It shall NOT activate based on voltage DC input at the Batt input terminal. Press SETUP for 20 flashes.

Change operational on/off voltages (13.2V on / 13.0V off default x2 for 24V) 25 flashes

If you wish to change the BB's activation voltages then you can do it here. The default is 13.2V on (x2 for 24V etc) and off is 13.0V (x2 for 24V etc). Press the SETUP button down for 25 flashes. Then the second column of LEDs shall flash. The voltages on this column then become the reference to activation voltages. The first option to select is 'on' activation voltage. Default is 13.2V (hence that LED flashes) - use the SETUP / SELECT buttons to toggle up and down to column to the desired activation voltage. Press and hold both buttons together to confirm voltage selection. Only the on voltage needs to be selected, the off voltage is always 0.2V below. These settings shall last until a factory reset has happened.

Set auto regenerative braking timer (default 240 seconds) 30 flashes

If no ignition feed is being used on the BB then this timer is relevant with EURO 6+ installations. With Euro 6 engines the alternator is often turned off during driving. This timer enables the BB to continue working even when the alternator is off. Within this timer window the ECU on board should prompt the alternator to turn on again as the ECU is monitoring the starter battery's depletion. When the alternator turns on again the voltage should climb up and the regen. braking timer restarts. The timer engages when the input voltage drops below the operational off voltage (default 13.0V, as above) and reactivates above the on voltage (13.2V, as above). **IF** ignition feed is applied to the unit this deactivates this braking timer. When ignition feed is no longer in use this timer reactivates. Press SETUP for 25 flashes. The second column of LEDs shall flash. Use the orange numbers as a reference with regards time in seconds. Use the SETUP / SELECT buttons to toggle the LEDs up and down that column to select the time you wish to set as the regen. braking timer. For EURO 6+ simply use ignition feed and do not worry about this feature.

Temperature voltage compensation (default on) 35 flashes

If you do not wish the BB to fluctuate output voltage based on temperature at the temperature sensor then this mode needs to be set to off. Default mode means that the BB shall elevate the voltage by the rate of 18mV per Deg C below 20Deg C and reduce the voltage by 18mV per Deg C above 20Deg C. You may need to set this to off if: You have a lithium battery and have set custom charge profile feature and you want to monitor the temperature at the battery because you want a 0Deg C trip, for example. If you are in a lithium profile (I or II) this mode is off anyway.

Turn off buzzer (buzzer on as default) 40 flashes

If the buzzer alarm is coming on and it annoys you, you can turn it off!. Please press the SELECT button down for 40+ flashes. This shall disable the buzzer altogether, indefinitely. You can reapply the buzzer function by repeating this procedure.

Maintenance Mode (default off) 45 flashes

This mode locks the unit in voltmeter mode so you can fault find. The columns of LEDs stay on as voltmeters. This is ideal if you do not have a voltmeter and you wish to provide information above what the input and output voltages are at the BB itself. The unit shall remain in Maintenance Mode until you repeat the 45 flashes or do a factory reset. Maintenance mode maintains charging function but the BB does not go into sleep and remains constantly live. The charger shall not go to sleep and shall remain on (not necessarily charging). The BB shall charge if the input voltage / ignition feed is as per normal operation. As the unit does not go to sleep the BB shall consume about 200mA at 12V (2.5W). This is compared with 1mA at 12V (0.12W) when in sleep mode.

Silence Buzzer



quick press

If the buzzer is sounding and you wish to silence it, simply press SETUP button with a quick but firm press. This should silence the buzzer. It is a short term feature. If you wish to turn the buzzer off forever, please press the SETUP button down for 40 flashes.

to view the status of the charger - do a quick press.

to view the BB as a voltmeter - do a quick press.

Display temperature



5 flashes

If you wish to view the temperature at the battery temperature sensor (if installed) - you can view it here. The temperatures that can view are between -30DegC and +2DegC on the front panel. If you wish to view a full range of temperature then you shall need the remote control BBURC.

Force unit to float



10 flashes

We recommend that you understand what float means before committing to float mode. It is basically a lower maintenance voltage - fairly harmless. Once you have forced the unit into float mode it shall remain there, forever - until you either do a factory reset or repeat this procedure.

Force unit to 1/2 power mode



15 flashes

This mode shall put the charger into half power mode. As the name suggests, if you have a 50A charger it shall put the maximum current to 25A. A 30A BB charger shall reduce to 15A (approximately) etc... The BB shall remain at half power forever, until either a factory reset is done or this method is repeated. You may need this mode if you want to reduce the current for the sake of keeping within the maximum charge rate of your batteries or due to pre-existing cabling being insufficient for the full power of the charger.

Force unit to night mode



20 flashes

This mode shall put the charger into half power mode (as above) but only for 8 hours at a time. The BB shall be on half power mode for these 8 hours only. It shall then resume as normal full power after these 8 hours. You have to repeat this procedure every time you need it.

Turn the charger to standby



25 flashes

If you wish to put your BB into standby then apply this mode. Standby is a one off setting. It shall stop the boost of the BB but shall remain on - pending a button press to get out of standby. The BB shall come out of standby during the next charge cycle, so is not a permanent setting. To indicate that standby is on LEDs 12 and 15 shall flash. Press any button to take out of standby.

Turn charger off



30 flashes

If you wish to turn your BB off then apply this mode. Off means the BB shall stop charging awaiting you to press either button. To turn off is a one off indefinite setting. It shall stop the boost of the BB - pending a button press to get out of standby. The BB shall turn on again only when a button is pressed. If the charger is disconnected and reconnected the BB shall remain off, also, during power cycles it shall remain off. To display the charger being off the top row of LEDs 12, 13, 14, 15 shall flash.

OEM lock



40 flashes

If you are an installer and wish to make settings to the BB and then lock the charger in these settings, to prevent tampering by the end user, then apply OEM lock. Once this mode has been applied NO options can be adjusted. Factory reset is the only method to remove this feature and restores the BB to defaults. The BB demonstrates OEM lock by flashing 4 Red corner LEDs.

Solar charger on* / off



45 flashes

the solar charge feature of the BBS1230 can be turned off, if not required. Default is on. Press the SELECT button for 45 flashes and let go, to turn off.

BBWS SOLAR only

BB charger on* / off



50 flashes

If you wish for the BBS1230 to be pure a solar charger and for the BB aspect to be switched off - use this mode. Press the SELECT button for 50 flashes and let go to turn the BB charging off. Solar charging ONLY! May be ideal for a bright sunny day and you wish to save a very small amount of fuel. **BBWS SOLAR only**

CUSTOM BATTERY TYPE SETTING (for expert use only - not required for general operation)

Before proceeding with this, please read and understand all instructions as it is quite complex and could take more than one attempt. There are timed intervals of 30 seconds per setting so it is very important to know exactly what you require before starting. If any errors are made simply wait a few minutes and you can start the cycle again. The settings offered for adjustment in sequence:

Important information: If during these operations you get yourself in a mess and find yourself pushing buttons aimlessly, then please resort to the factory reset. To delete all and return the product to its default factory settings.

- A)** Boost / absorption voltage (high voltage charge).
- B)** Conditioning voltage (medium charge rate normally between boost and float voltage).
- C)** Float voltage (no longer charging, this will provide voltage at a reduced level to maintain the batteries and provide power for any loads applied).
- D)** Absorption time factor adjust. The length of time spent in absorption can be adjusted by a factor 0-18. This may be beneficial for different battery chemistries. Gel, for example, tends to absorb current at a low rate, thus, increasing the length of time spent in absorption may be beneficial (set nearer 18). AGM, the reverse (set nearer 0). If in any doubt, ask your battery retailer or simply use one of our preset values. To calculate the absorption time from the time factor simply multiply the factor number (0-18) by the length of time it takes for the charging voltage to hit the absorption voltage (typically 14.4V). If it takes 40 minutes to reach absorption and you set your ATF to 4 then $4 \times 40 \text{ mins} = 160 \text{ minutes}$. The maximum time the unit can stay in absorption is 24 hours 1440 minutes.
- E)** Minimum and maximum absorption times.

Here you can set the maximum and minimum time the unit stays in absorption. For example, you may have AGM that may need a maximum of one hour, or GEL which could require a minimum of 720 minutes (12 hours).

We recommend that you write down your required voltages and times in the space below. This is so you know what to programme during setup.

Desired custom values - make a note.

- Boost / bulk / absorption (V) _____
- Conditioning (V) _____
- Float (V) _____
- Absorption Time Factor (0-18) _____
- Absorption Minimum (0-960 minutes) _____
- Absorption Maximum (0-960 minutes) _____

Operation

Press and hold SETUP button for 10 flashes, let go.

All of the first column of LEDs shall flash

Press the setup/select button to move LED down to custom. Hold both buttons for 2 seconds to confirm.

Opportunity to adjust Fast Charge / Bulk / Absorption voltage.

Red Custom LED will flash for 3 seconds to confirm. Red Custom LED will come on constant, Green Fast Charge LED will flash (section 1 on graph). Adjust Fast Charge voltage by using the Select and Setup buttons to go up and down the right LED column to select the correct Fast Charge voltage. Once content, wait 30 seconds, or press both buttons to confirm. The unit shall then proceed to Conditioning charge voltage (next below).

Opportunity to adjust Conditioning charge voltage

Red Custom LED will come on constant and Green Conditioning LED will flash (section 3 on graph). Likewise, adjust the conditioning voltage by using the Select and Setup buttons to go up and down the right LED column to select the correct Conditioning voltage. Once content, wait 30 seconds, or press both buttons to confirm. The unit shall then proceed to float voltage set (next below).

Opportunity to adjust float charge voltage

Red Custom LED will come on constant and Blue Float LED will flash (section 3 on graph). Likewise, adjust the float voltage by using the Select and Setup buttons to go up and down the right LED column to select the correct Float voltage. Once content, wait 30 seconds, or press both buttons to confirm. The unit shall then proceed to float voltage set (next below).

Opportunity to adjust absorption time factor

Red High Temp LED will come on constant. Green Fast Charge LED will flash and Blue Float LED will flash (section 1 and 4 on graph). This time, adjust the time by using the Select and Setup buttons to go up and down the right LED column (refer to the blue scale 0-18) to select the correct time. Once content, wait 30 seconds, or press both buttons to confirm. The unit shall then proceed to minimum absorption time factor (next below).

Why use Absorption Time Factor (ATF)?

ATF is simply a number (0-18) that can be used to multiply by the length of time the charger takes to reach the absorption voltage from start. For example, if the absorption voltage is reached in 10 minutes with the ATF at 4, then $10 \text{ mins} \times (\text{ATF } 4) = 40 \text{ mins}$ of absorption.

Opportunity to adjust minimum absorption time factor

Red High Temp LED will come on constant. Yellow Absorption LED will flash and blue Float will flash (section 2 and 4 on graph). This time, adjust the time by using the Select and Setup buttons to go up and down the right LED column (refer to the brown scale 0-960) to select the correct time. Once content, wait 30 seconds, or press both buttons to confirm. The unit shall then proceed to maximum absorption time factor (next below).

Opportunity to adjust maximum absorption time factor

Red High Temp LED will come on constant. Green Conditioning LED will flash and blue Float will flash (section 3 and 4 on graph). This time, adjust the time by using the Select and Setup buttons to go up and down the right LED column (refer to the brown scale 0-960) to select the correct time. Once content, wait 30 seconds, or press both buttons to confirm.

A green LED from the middle of each row will flash for around 8 seconds to confirm the setup is completed. The unit will then restart.

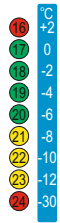

Opportunity to adjust temperature sensor trip. FINAL custom setting.

The final setting to adjust in the custom configuration is to set temperature trip. This turns off the BB's charging if this temperature is reached at the temp sensor (if temp sensor not fitted, then this mode is irrelevant). The default, as it assumes lead acid, is -30 Deg C, so the RED LED at the bottom shall illuminate (24). For lithium, bring this LED up to your desired trip temperature. E.g 0, -2, -4 Deg C etc. Use the SETUP and SELECT button to bring the LEDs up and down the second column to the desired temperature. Press both buttons to confirm the selection. If you have lead acid batteries. We recommend leaving it at -30DegC (default) - if charging lead acids. Lithium batteries may vary around the 0DegC mark.

Adjustment of operational voltages.

The 4 main control voltages below are inextricably linked. The voltages can only be adjusted as a block (not individually). For example, if you wish to reduce the Cutoff voltage by 0.2V then all other voltages in the block shall reduce by 0.2V.

Charging voltage	13.5V
Cutoff voltage	13.2V
↕ regen braking timer	
Lower voltage trip	12.0V
Volt. trip w/ ignition	10.0V

Input voltage

All 4 voltages are always linked. This block can be adjusted by changing the Cutoff voltage value up and down. This subsequently changes the other three voltages by the same value.

Charging voltage (default 13.5V) (always 0.3V above Cutoff voltage): At this voltage the charger starts charging. After 5 seconds above 13.2V the regen braking timer is set. If the input voltage drops to 11.9V - 13.0V this timer begins. Timer reset when input voltage is 13.2V+.

Cutoff voltage (default 13.2V): This voltage is only relevant after the charging voltage has been met and the charger is charging. When the input voltage drops below this cutoff voltage the charger stops charging and shall eventually go to sleep. If the input voltage remains between 13.2V-13.5V the charger shall continue charging. The Cutoff voltage is the parameter that the user changes. As noted, by adjusting the Cutoff voltage you change the other three voltages mentioned by the same amount.

Lower voltage trip (default 12.0V) (always 1.2V below Cutoff voltage): When the input voltage drops below the Lower voltage trip the charger turns off. The 11.9V threshold is only relevant if the regen braking timer is activated. If not, then the low voltage trip is 13.0V. If in ignition feed mode, the low voltage trip is 10.0V.

Low voltage trip (default 10.0V) always 3.0V below Cutoff voltage):

During this particular setup procedure we have made the voltage setup LED bar more sensitive so that the adjustment can be made in 0.1V increments. For example, for 13.1V the 13V LED is on and the 13.4V LED is flashing. The same idea for 12.9V. The 13V LED is on and the 12.6V LED is flashing. **Remember that you are adjusting the Cutoff voltage** whilst simultaneously adjusting the **Charging voltage, Lower voltage trip and the Low voltage trip.**

13.4V	13.4V LED ON
13.3V	13.4V LED ON + 13.0V LED FLASHING
13.2V	13.4V LED ON + 13.0V LED ON
13.1V	13.4V LED FLASHING + 13.0V LED ON
13.0V	13.0V LED ON
12.1V	12.2V LED FLASHING
12.0V	12.2V LED FAST FLASHING

To enter the menu press (SETUP/ENTER) & SELECT for more than 20 seconds.

BOOST, ABSORPTION, CONDITIONING and FLOAT LEDs will flash to indicate Cutoff voltage Setting Menu. At the same time the actual Cutoff voltage will be displayed in the left LED voltage bar according to the description above. To decrease voltage press SETUP/ENTER and to increase voltage press SELECT button.

The Cutoff voltage range you can choose is between 12.0V-14.6V.

Charging voltage is always 0.2V higher. Lower voltage trip is always 1.1V lower. Low voltage trip (ignition mode) is always 3.0V lower.

If you do not touch any buttons for 30 seconds the default voltage of 13.0V shall be restored and saved.

To confirm your custom voltage you must press both buttons (SETUP/ENTER) and (SELECT) simultaneously for 2 flashes.

The chosen voltage will be saved and the unit will restart. If you feel unsure, do not touch any buttons. The default value will be restored automatically.

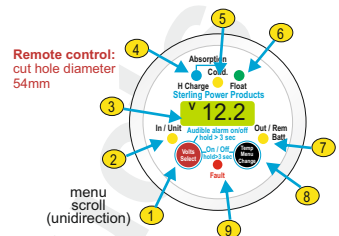

- 1) Volts select button.
- 2) Voltage displayed is voltage into product.
- 3) LCD screen with backlight.
- 4) Fast charge led indicator.
- 5) Condition battery stage.
- 6) Charge complete on float.
- 7) Voltage displayed is volts out of product.
- 8) Scroll menu button.
- 9) Screen display showing a unit fault.

Volts Select Button (left)



Quick push = back light on.
Short press ~1 second = input voltage, press again for output voltage, press again for remote sense voltage.

Hold for 4 seconds to toggle between buzzer on/off, **bu2** should appear.

Both Left and Right buttons



Hold both buttons for 2 seconds to force to float **FfF**, toggle on / off.

Press and hold both buttons for 4 seconds to enter standby mode, **Stb** should appear. Repeat to turn unit on.

Press and hold both buttons for 6 seconds to turn unit off. **oFF** shall appear. Repeat to turn unit on.

Temp Menu Change (right button)



Quick press = back light on.
Short hold ~1 second = switch between unit's temperature and temperature sensor. If **nc** appear it means that the temperature sensor is not connected.

Hold for 2 seconds to toggle night mode on / off, **nn** should appear. 1/2 power for 8 hours.

Remote Error Codes	
E00	= high input voltage
E01	= high output voltage
E02	= high unit temp
E03	= high batt. temp
E04	= no output voltage

Setup - Menu:

to escape menu hold both buttons down until 'END' appears. Or, just leave the remote for 10 seconds.

Toggleing is unidirectional

"rt" displays remaining absorption or conditioning time Press "select" button to see value.

"btY" displays battery profile type (0-9). This number denotes which charging profile the charger is set to. Press "select" to see value. (Ref: table labelled 'Battery Chemistry Selection' on).

"coU" displays input cut off voltage (the voltage at which the unit stops charging) (13.4V). Press "select" to see value.

"loU" display input / output base voltage (12/24V). Press "select". First input voltage will be displayed with "in" LED on for 3 sec. then output voltage with "out" LED on for 3 sec.

"C/F" change from celsius to fahrenheit or back* (default = celsius). Press "select" button to enter setting. Then press right button to change between Fahrenheit (FAH) and Celsius (CEL). Confirm setting by pressing "select" button.

"CL" set current limit to 1/2 or 1/1 (full). Press "select" button to see actual setting. Press "change" (right) button to change setting. Press "select" to confirm setting.

"buC" turn Buzzer on / off (default = on). Press "select" to see actual setting. Press "change" button to change between settings. Press "select" again to confirm setting

"Asc" Autocscroll on / off (default = off). Press "select" to see actual setting. Press "change" button to change between settings. Press "select" again to confirm setting.

"Von" Voltage / temp display during standby and sleep. Toggle between on and off, press "select" (left) button to select.

"con" change contrast* value from 0 to 7 (default = 3). Press "select". First the lowest and the highest value will be displayed. Then the actual value. Press "change" button to change settings. Press "select" again to confirm setting.

"bLc" change backlight colour*. off <- auto -> green -> red -> blue (default = auto). Press "select" to see actual setting. Press "change" button to change between settings. Press "select" again to confirm setting.

"bLt" change backlight time*. 1 - 600 seconds, 0 = always on, (default = 60). Press "select". First the lowest and the highest value will be displayed. Then the actual value.

"br9" change remote display colour red to green voltage threshold.* 8.0V-13.3V (default 12.4V). When below 12.4V display is red and when 12.4V or above the remote goes green. When Press "select". First the lowest and the highest value will be displayed.

Then the actual value. Press "change" button to increase value. Hold "change" button to accelerate. When max. value reached it will start with lowest value. Press "select" again to confirm setting. Press "change" button to increase value. Hold "change" button to accelerate. When max. value reached it will start with lowest value. Press "select" again to confirm setting.

"b9b" change voltage from green to blue backlight* 12.4 - 16.0V (default 13.4V). Press "select". First the lowest and the highest value will be displayed. Then the actual value. Press "change" button to increase value. Hold "change" button to accelerate. When max. value reached it will start with lowest value. Press "select" again to confirm setting.

"Led" change LED on time 1 - 600 seconds, 0 = always on, (default = 60). Press "select". First the lowest and the highest value will be displayed. Then the actual value. Press "change" button to increase value. Hold "change" button to accelerate. When max. value reached it will start with lowest value. Press "select" again to confirm setting.

"uld" display Unit ID. Press "select". Value will be displayed for 5 sec.

"uSW" display unit software version. Press "select". Value will be displayed for 5 sec.

"rSW" display remote software version. Press "select". Value will be displayed for 5 sec.

"Loc" Unit lock code = 1 to 999 (default = 00 = unlocked).

WARNING This mode shall lock menu setting options of the unit by virtue of a pass code, be careful. Press "select" to enter "Loc" setting. Press "change" button to increase value, hold to accelerate. Stop when on the number you require and press "select" button to confirm. The software shall store this number, then the display shall read: **loc** -> on -> #. # = number you have stored. To remove **loc**, return to **loc** and re-enter the number, Press "select" button and the display should read: **loc** -> off (green back light). **Please make a note of this loc code here:** _____.

"rSt" Resets remote to default values*. Press "select". "NO" will be displayed. Press "change" to toggle between "YES" and "NO". Confirm by pressing "select". rSt will display if resetting.

"rSu" Resets the battery charger to default settings. Press "select". "NO" will be displayed. Press "change" to toggle between "YES" and "NO". Confirm by pressing "select". rSt will display if resetting.

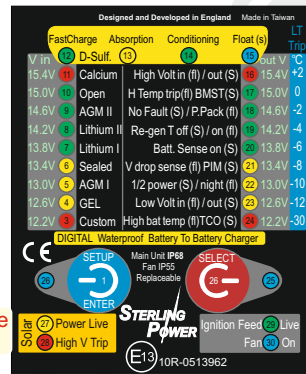
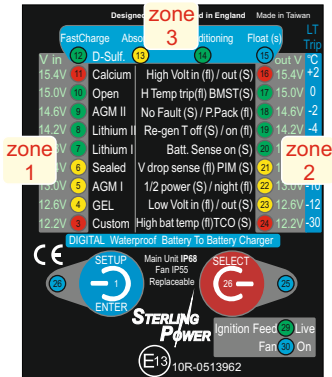

Battery to battery chargers are complex systems that have a lot of external sources impacting upon them. The response of the product, as the product designer and engineer I simply cannot see how it possible for some companies to make this product with no back feed information to the new owner.

The BB panel will display normal every day input and output voltages (most of the time). When in alarm mode or in setup / select feature mode then the display shall denote something different. It is important to distinguish this.

In basic terms, if at least, one LED on each section is on then all operation is okay and you are reading the voltmeter. If only 1 LED is on in box 2 then it's a fault.

if all the 4 LEDs are flashing in zone 3 then the product has been manually switched off in the control panel, see instructions.

this panel may at first be very daunting but its broken down into 3 simple modes or operation (4 for the solar version), they are:

- Normal every day operation: at least 1 LED on in Zone 1- 2 and 3.
- Alarm mode / warning / fault finding: 1 LED only on in Zone 2.
- System adjust / battery type / special operation setup 1 LED Zone 1.
- Solar BB only. Zone 4.

Using the solar unit as an example (as it has the 4 areas).

Zone 1 - Primarily concerned with displaying the input voltage to the unit. Either from the starter battery / alternator or from solar.

Zone 2 - is primarily concerned with displaying the output voltage from the unit (plus alarms and setup information, see more details in the instructions).

Zone 3 - is primarily concerned in showing the progression of the charge (however, can show other information).

Zone 4 - is only concerned with the solar operation mode.

On initial startup all the LEDs and fan will come on in sequence to simply show all the lights etc are okay. Then one LED only will operate in Zone 1 for seconds to show which battery chemistry is in operation in the product. After that the unit will go into normal operation mode. It is vital to notice that there must be at least 1x LED on each of the areas 1/2/3. Of this there is at least 1x LED on in each of the 3x Zones when the product is working in normal mode and the LEDs are showing voltages in areas 1 and 2 and battery charge progression in Zone 3.

Reading the voltage: Take, for example, the input voltage. If only one LED is on say '13.8V' then the input voltage is 13.8V. However, if the 13.8V LED is on and also the 14.2V LED is flashing then the voltage is between 13.8V and 14.2V, but closer to the solid LED (so 13.9V). If the 13.8V is on and the 13.4V is also on then the voltage is between 13.8V and 13.4V, so about 13.6V. This is true for both input and output voltmeters.

If only 1 LED is on area 2 and no LEDs on in area 1 and 3 then this is a fault condition, as such the text faults are what the LED is indicating (and no longer the voltage).

Solar Panel Zone 4, when the solar unit is in operation (i.e. engine stopped) then, when the yellow LED in Zone 4 marked solar power live, then the input voltage scale will change, it will move from the gray voltage scale (normal operation) to the yellow voltage scale (but only when the yellow solar LED is on, the voltage measurement concept is the same).

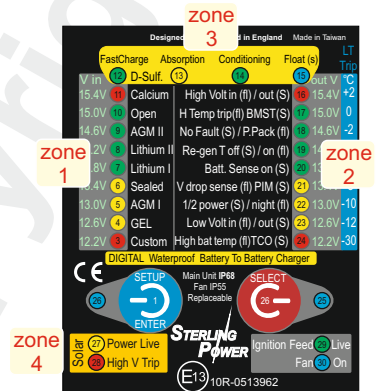

Firstly, ensure the Pro Batt Ultra (BB) is wired up as per page 6 / 7. Ensure negatives are common and the BB charger's negative is connected to the starter battery's negative - avoid connecting to chassis negative. Voltages between common negatives should be ~0V.

Secondly, to test the BB, remove (or turn off) any secondary charging source like AC to DC battery chargers or solar chargers going to the battery banks. Leave the primary charger connected (alternator) - ensure alternator is working. We also recommend turning off any loads (inverters etc.).

How to test if the Pro Batt Ultra (BB) is charging:

With engine running (alternator charging), what is the voltage on the input terminal of the BB? What is the voltage on the output terminal of the BB? Measure these voltages at the BB's terminals, not at the batteries terminals.

Even though, by default, the BB can work down at 12.0V on the input; it still requires over 13.5V+ to turn on and get going. If you are getting alternator voltage at the input terminal (~14V) and 14V+ on the output terminal the chances are your BB is working fine. If little to no current is passing through the charger at these voltages then the batteries are either full or they are deceased. If the output voltage is between 13V-14V (but rising) then you could have a situation where the output batteries were very low in charge (or large in capacity) and the charger shall be charging at maximum current. Provided the voltage continues rising the BB is charging.

If your output voltage is less than 13V and your input voltage is healthy, it could be three things:

- 1) You have a large load on your output bank - turn load off.
- 2) The BB has been turned off - hold SELECT button for 10 flashes and let go, to turn on again.
- 3) The BB is not working.

If your input voltage is less than 13V, it could be several things:

Automotive: Your alternator's voltage is at less than 13V (the alt. is regenerative braking mode - sometimes expected on modern Euro 5/6+ engines) - take vehicle for drive and measure alternator's voltage and set up the BB to suit these needs. All vehicle manufacturers have their own software / characteristics for regen. braking.

Automotive or Marine: If your alternator's voltage is ~14V then check continuity between the alternator's B+ terminal and the starter battery. If you are getting ~14V on starter battery then check continuity between starter battery and BB input terminal.

Automotive or Marine: If your alternator's voltage is 0-13V (starter battery voltage) then alternator may have failed. Or, requires increase rpm of engine, possible belt slip. Or, your alternator current rating is lower than the rating of the BB. Possibly set BB to half power mode. You need a larger alternator.

Is your output voltage slightly higher or lower than expected - even with no loads / chargers on?

Check if you have the temperature sensor connected. If so, no problems leaving it there, it is simply voltage compensating for when the temperature at the sensor is lower or higher than the benchmark 20DegC (69F). If lower, then the voltage shall rise and vice versa. The further from 20DegC in either direction leads to proportional increase or decrease in the voltage.

Possible, voltage drop across long cabling / fuse holder / diode. Use our remote sense connection on the unit - refer to page 6, yellow wire.

LED 16 flashing red - over voltage on input. This LED comes on if there is 19V for more than 3 seconds on the input terminal. Check the voltage at the input. Possible regulator fault, or alternative charger's voltage is too high.

LED 16 solid red - Over voltage output. There is 16V+ for more than 3 seconds on output terminal. Check the voltage at the output. Turn charger off, if voltage drops when off and rises again when turned on the possible charger fault. If 16V+ irrespective of charger being on then check alternative charging source.

LED 17 flashing red - over temperature. Unit has become too hot and switches off. Possible defective fan. Or, high ambient temperature, ensure good ventilation or the charger's vents may be blocked

LED 21 flashes yellow - high voltage drop across output cable. When the battery voltage sensor is connected the device has detected too high a voltage drop between the output and the positive terminal of the battery (>1.5V). Verify that the cable thickness is sufficient. Possibly the terminals are corroded or bad connection. Also check if the cable is actually connected to the battery.

LED 22 solid yellow or flashing - the charger is in 1/2 power. It has either been manually forced into 1/2 power mode or night mode (refer to page 11-13). Or, the charger has engaged 1/2 power mode itself due to the device's temperature (> 85°C). In this case, check the fan and the ambient temperature. Possibly the installation is not properly ventilated. Make the adequate ventilation.

LED 23 solid yellow or flashing - undervoltage. If the LED flashes, the input voltage is too low. Check the alternator or the charging source of the starter battery. If the LED is solid, the output voltage is very low - output batteries are likely to be defective.

LED 24 flashing red - high battery temperature. The unit has shut down due to excessive battery temperature (> 55°C). Either the battery is defective or the ambient temperature is too high. Provide adequate ventilation.

Customer Service & Warranty

Cutting of the pre-wired / pre-fused cable shall void warranty.

Your 100 % satisfaction is our goal. We realise that every customer and circumstance is unique. If you have a problem, question, or comment please do not hesitate to contact us. We welcome you to contact us even after the warranty and return time has passed.

Product Warranty:

Each product manufactured by Sterling Power comes with at least a 2 year limited factory warranty. Certain Products have a warranty period of time greater than 2 years. Each product is guaranteed against defects in material or workmanship from the date of purchase. At our discretion, we will repair or replace free of charge any defects in material or workmanship that fall within the warranty period of the Sterling Power product. The following conditions do apply:

- **The original receipt or proof of purchase must be submitted to claim warranty. If proof cannot be located a warranty is calculated from the date of manufacture.**
- **Our warranty covers manufacture and material defects. Damages caused by abuse, neglect, accident, alterations and improper use are not covered under our warranty.**
- **Warranty is null and void if damage occurs due to negligent repairs.**
- **Customer is responsible for inbound shipping costs of the product to Sterling Power either in the USA or England.**
- **Sterling Power will ship the repaired or warranty replacement product back to the purchaser at their cost.**

If your order was damaged in transit or arrives with an error, please contact us ASAP so we may take care of the matter promptly and at no expense to you. This only applies for shipping which was undertaken by our company and does not apply for shipping organised by yourself. Please do not throw out any shipping or packaging materials.

All returns for any reason will require a proof of purchase with the purchase date. The proof of purchase must be sent with the returned shipment. If you have no proof of purchase call the vendor who supplied you and acquire the appropriate documentation.

To make a claim under warranty, call our customer care line at (USA 1-(207)-226-3500, England 01905 771771). We will make the best effort to repair or replace the product, if found to be defective within the terms of the warranty. Sterling Power will ship the repaired or warranty replacement product back to the purchaser, if purchased from us.

Please review the documentation included with your purchase. Our warranty only covers orders purchased from Sterling Power. We cannot accept warranty claims from any other Sterling Power distributor. Purchase or other acceptance of the product shall be on the condition and agreement that Sterling Power USA LLC and Sterling Power LTD shall not be liable for incidental or consequential damages of any kind. Some states may not allow the exclusion or limitation of consequential damages, so, the above limitations may not apply to you. Additionally, Sterling Power USA and Sterling Power LTD neither assumes nor authorizes any person for any obligation or liability in connection with the sale of this product. This warranty is made in lieu of all other obligations or liabilities. This warranty provides you specific legal rights and you may also have other rights, which vary from state to state. This warranty is in lieu of all other, expressed or implied.

Sterling Power Products Ltd
England
www.sterling-power.com

Sterling Power USA
Warranty Service Center
www.sterling-power-usa.com