



TRAILER

12' 10' 8"
OWNER'S
MANUAL

MINN-KOTA



TABLE OF CONTENTS

Comprehensive Five-Year Warranty..... 3-4

Introduction 5

Getting Started..... 6

 Using Your Remote..... 6

 Programming a New Remote 6

Using Your Talon 7-12

 Auto-Deploy/Retract..... 7

 Auto-Drive..... 7

 Depth Indication..... 8

 Wave Absorption 8

 Manual Retraction Procedure..... 9

 Mode Functions 10

 Deployment Notification Alarm..... 11

 Retraction Notification Alarm..... 11

 Removal and Storage..... 12

Service and Maintenance..... 13-15

 Remote Battery Replacement 13

 Cleaning the Unit 13

 Replacing the Spike..... 14

 Fuse Reset 15

Rigging Accessories..... 16-17

 Adapter Brackets..... 16

 Adapter Brackets and Rigging Accessories 17

Accessories..... 18-19

Parts List 20-24

Compliance Statements..... 25-26

COMPREHENSIVE FIVE-YEAR WARRANTY

WARRANTY ON MINN KOTA® TALON SHALLOW WATER ANCHORS

MINN KOTA LIMITED FIVE-YEAR WARRANTY ON MECHANICAL PARTS

(ALL EXCEPT, CONTROL BOARD, MOTOR, REMOTE, BRACKET, AND SPIKE*)

Johnson Outdoors Marine Electronics, Inc. warrants to the original purchaser that the purchaser's entire Minn Kota Talon shallow water anchor's mechanical parts are free from defects in materials and workmanship appearing within five (5) years after the date of purchase. Johnson Outdoors Marine Electronics, Inc. will (at its option) either repair or replace free of charge, any mechanical parts found to be defective during the term of this warranty. Such repair or replacement shall be the sole and exclusive liability of Johnson Outdoors Marine Electronics, Inc. and the sole and exclusive remedy of the purchaser for breach of this warranty.

*The spike is covered by the 5 year mechanical parts warranty (part plus labor to install). After the 5 year mechanical parts warranty the spike will be covered by the limited lifetime warranty (part only).

MINN KOTA LIMITED TWO-YEAR WARRANTY ON ELECTRICAL PARTS

(CONTROL BOARD, MOTOR, REMOTE)

Johnson Outdoors Marine Electronics, Inc. warrants to the original purchaser that the purchaser's Minn Kota Talon shallow water anchor's electrical parts are free from defects in materials and workmanship appearing within two (2) years after the date of purchase. Johnson Outdoors Inc. will, at its option, either repair or replace, free of charge, any electrical parts, found to be defective during the term of this warranty. Such repair or replacement shall be the sole and exclusive liability of Johnson Outdoors Marine Electronics, Inc. and the sole and exclusive remedy of the purchaser for breach of this warranty.

MINN KOTA LIMITED LIFETIME WARRANTY ON THE SPIKE

Johnson Outdoors Marine Electronics, Inc. warrants to the original purchaser that the spike of the purchaser's Minn Kota Talon shallow water anchor is free from defects in materials and workmanship appearing within the original purchaser's lifetime. Johnson Outdoors Marine Electronics, Inc. will provide a new spike, free of charge, to replace any spike found to be defective more than five (5) years after the date of purchase. Providing a new spike shall be the sole and exclusive liability of Johnson Outdoors Marine Electronics, Inc. and the sole and exclusive remedy of the purchaser for breach of this warranty; and purchaser shall be responsible for installing, or for the cost of labor to install, any new spike provided by Johnson Outdoors Marine Electronics, Inc.

TERMS AND CONDITIONS

These limited warranties do not apply to products used in saltwater (except the Chargers, Talon, and Riptide models) or commercially, nor do they cover normal wear and tear, blemishes that do not affect the operation of the product, or damage caused by accidents, abuse, alteration, modification, misuse or improper care or maintenance. DAMAGE CAUSED BY THE USE OF OTHER REPLACEMENT PARTS NOT MEETING THE DESIGN SPECIFICATIONS OF THE ORIGINAL PARTS WILL NOT BE COVERED BY THIS LIMITED WARRANTY. The cost of normal maintenance or replacement parts which are not defective are the responsibility of the purchaser.

MINN KOTA SERVICE INFORMATION

To obtain warranty service in the U.S., the product believed to be defective, and proof of original purchase (including the date of purchase), must be presented to a Minn Kota Authorized Service Center or to Minn Kota's factory service center in Mankato, MN. Any charges incurred for service calls, transportation or shipping/freight to/from the Minn Kota Authorized Service Center or factory, labor to haul out, remove, re-install or re-rig products removed for warranty service, or any other similar items are the sole and exclusive responsibility of the purchaser. Products purchased outside of the U.S. must be returned prepaid with proof of purchase (including the date of purchase and serial number) to any Authorized Minn Kota Service Center in the country of purchase. Warranty service can be arranged by contacting a Minn Kota Authorized Service Center or by contacting the factory at 1-800-227-6433 or email service@minnkotamotors.com.

NOTE: Do not return your Minn Kota product to your retailer. Your retailer is not authorized to repair or replace products.

THERE ARE NO EXPRESS WARRANTIES OTHER THAN THESE LIMITED WARRANTIES. IN NO EVENT SHALL ANY IMPLIED WARRANTIES, INCLUDING ANY IMPLIED WARRANTIES OF MERCHANTABILITY OR FITNESS FOR PARTICULAR PURPOSE, EXTEND BEYOND FIVE YEARS FROM THE DATE OF PURCHASE. IN NO EVENT SHALL JOHNSON OUTDOORS MARINE ELECTRONICS, INC. BE LIABLE FOR INCIDENTAL, CONSEQUENTIAL OR SPECIAL DAMAGES.

Some states do not allow limitations on how long an implied warranty lasts or the exclusion or limitation of incidental or consequential damages, so the above limitations and/or exclusions may not apply to you. This warranty gives you specific legal rights, and you may also have other legal rights which vary from state to state.

INTRODUCTION

OVERVIEW

Thank you for purchasing the Minn Kota® Talon shallow water anchor. This revolutionary shallow water anchor uses state-of-the-art technology to deliver unprecedented levels of boat control. Intuitive features and wireless control enable Talon to accurately position your boat and improve your bait presentation. Talon holds your boat in position so you can focus on fishing. By following instructions in this manual, you will learn how to properly install and operate your new Talon for years of trouble free use. We encourage you to read this manual thoroughly in order to maximize your product experience.

SAFETY AND CAUTIONS

You are responsible for the safe and prudent operation of your vessel. We have designed Talon to be an accurate and reliable tool that will enhance boat control and improve your ability to catch fish. This product does not relieve you from the responsibility for safe operation of your boat. You must avoid hazards to anchoring and always maintain a permanent watch so you can respond to situations as they develop.

CAUTION: Never leave the boat unattended with the Talon as your only boat anchor. Talon is not intended to provide primary anchorage.

TALON REGISTRATION CARD

To receive all the benefits of your product warranty please fill out and mail the registration card, you may also register your product online at minnkotamotors.com.

LOCATING YOUR SERIAL NUMBER

Your Minn Kota 11-character serial number is very important. It helps to determine the specific model and year of manufacture. When contacting Consumer Service or registering your product, you will need to know your product's serial number. We recommend that you write the serial number down in the space provided below so that you have it available for future reference.

The serial number on your Talon is located below the motor housing.

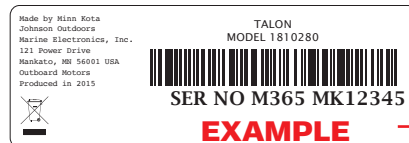

Model: _____

Serial Number: _____

Purchase Date: _____

Store Where Purchased: _____

GETTING STARTED

USING YOUR REMOTE

Your Talon comes direct from the factory with two remotes pre-programmed to your unit. Each remote includes a lanyard that may be attached to either end of the remote to suit your preference. The remote has two buttons: UP and DOWN.

 **To Deploy:** Press the DOWN button twice within 1/2 second.

 **To Retract:** Press the UP button once.

To Stop: Press the UP button  once or DOWN button  twice within 1/2 second.

Each remote uses a CR2032 size lithium coin cell battery. See page 13 for instructions on how to replace the battery.







Note: Certain international models may use a different wireless device for Talon controls other than what is shown in these instructions. The instructions for programming and operation of those devices are included in those specific models.







PROGRAMMING A NEW REMOTE

Your Talon can store 10 total remote IDs. If 10 IDs have been learned to the Talon unit and an eleventh remote is learned, the first ID learned will be overwritten with the eleventh remote ID. The new remote will be learned, the oldest will be erased.

TO LEARN A NEW REMOTE ID

1. Retract the anchor if it is not already retracted by pressing the Auto UP switch .
2. After the anchor has retracted, press and hold the Auto UP switch  on the Talon. A steady tone  will be heard.
3. While continuing to press the Auto UP switch , press the UP button  on the new remote one time.
4. A series of 3 beeps  will be heard, indicating the new remote has been learned.
5. Release the Auto UP switch  on the Talon after the 3 beeps begin.



TO ERASE ALL STORED REMOTE IDS (THIS MAY REQUIRE ASSISTANCE FROM A SECOND PERSON)

1. Retract the anchor if it is not already retracted.
2. Disconnect the white power lead from the battery.
3. Press and hold the Auto UP switch  on the Talon.
4. While continuing to press the Auto UP switch , reconnect the white power lead to the battery.
5. A series of fast beeps will be heard and then a long steady tone .
6. Release the Auto UP switch  after the long steady tone has begun. All remote IDs are now erased.



USING YOUR TALON

AUTO-DEPLOY/RETRACT

DEPLOY

Raising and lowering your Talon can be done wirelessly from anywhere in the boat using your remote or directly through the control panel. Two button presses (within 1/2 second) of the remote DOWN button  or one button press of the control panel Auto DOWN button  automatically deploys the anchor.

RETRACT

One button press of the remote UP button  or control panel Auto UP button  automatically raises the anchor to the retracted position. Talon shuts off automatically when completely retracted. There is no need to hold down a switch or button.



AUTO-DRIVE

Talon's revolutionary Auto-Drive feature stops your boat with greater speed and precision than the competition. Two button presses (within 1/2 second) of the remote DOWN button  not only deploys your anchor automatically, but Talon actually drives the anchor in for you to ensure the anchor is seated. Talon's Auto-Drive deploy shuts the anchor off when the spike contacts the bottom. Auto-Drive will automatically power the spike into the bottom with three successive hits, using increasing force on each hit.

Note: Attempting to retract the Talon BEFORE it has completed its automated deployment sequence, will only cancel the deployment sequence in process, and not retract the Talon. You may retract the Talon normally when a deployment sequence has been completed or cancelled.

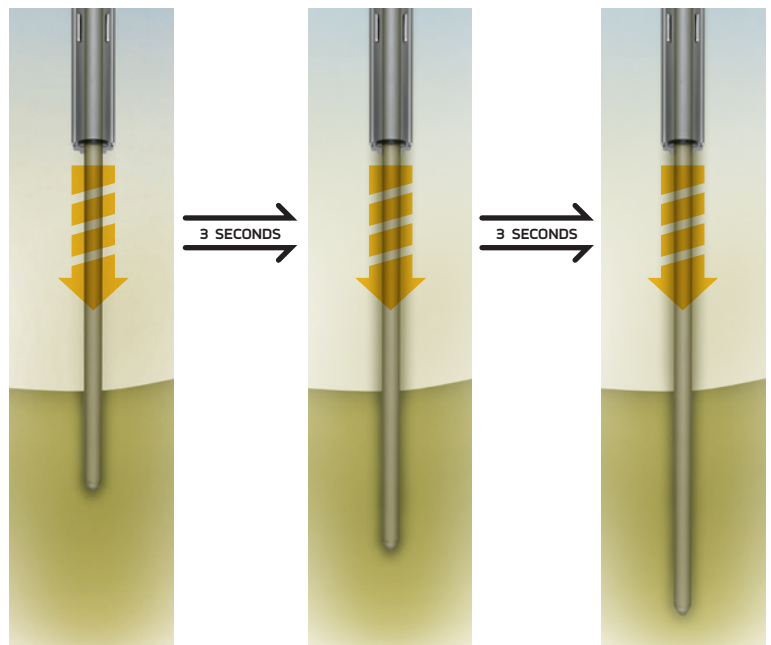

DEPTH INDICATION

DEPLOY

Talon shows your deployed status of the anchor via the high visibility LED display on your control panel. It will display one light for every two feet of deployment and the current depth indicator will blink while in motion until it reaches the next full increment. Know the immediate status of your anchor, or deploy the Talon to a specific length for stopping during drift.

1 LED per every 2 feet of deployment depth



WAVE ABSORPTION

Talon enables your boat to move up or down without affecting the anchor. It uses a built-in floating suspension to keep your boat locked to the bottom, even in rough water conditions.







MANUAL RETRACTION PROCEDURE

In the event of a power failure or other occurrence where the Talon cannot be retracted in the normal manner, your Talon can be manually retracted.

Minn Kota recommends keeping a $\frac{7}{16}$ " socket and socket wrench in your boat, as they are required for the manual retraction procedure.

TO MANUALLY RETRACT

1. Press and HOLD the UP  button on the control panel until you hear 3 successive beeps .
2. Remove protective rubber cap to access the manual retraction hex-drive. Using a $\frac{7}{16}$ " socket wrench crank the hex feature (shown below) in a clockwise direction.
3. Continue to crank the hex feature until the Talon is fully retracted. Visually confirm (at the base of the unit) that the spike has fully retracted.
4. **IMPORTANT:** Once you have confirmed that the Talon is now fully retracted, you must turn the manual retract mode OFF BEFORE using your Talon again. To do this, press the UP  button on the control panel one time. You will hear the same 3 beep sequence  confirming that the manual retraction mode has been turned OFF.



MODE FUNCTIONS

STANDARD MODE

No mode LED illuminated . Auto Deploy will initiate the 3-hit sequence with maximum down-force power.

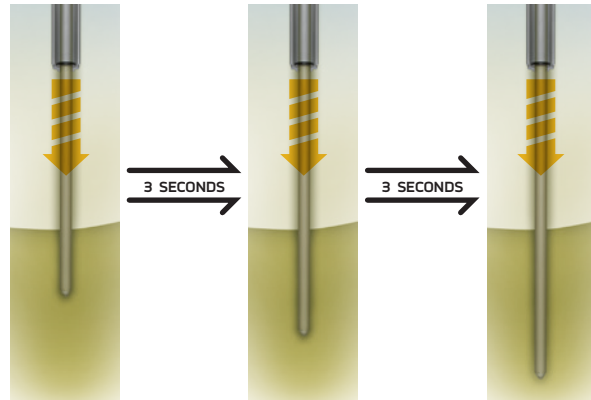

SOFT BOTTOM MODE

Green mode LED illuminated . Auto Deploy will initiate a single hit sequence only, at reduced power.

IMPORTANT: Talon is capable of anchoring in any condition and it is important to select the right anchoring mode. During calm conditions, or on water with muddy or soft sandy bottoms, SOFT BOTTOM mode will prevent over-anchoring.



ROUGH WATER MODE

Red mode LED illuminated . Auto Deploy will initiate the 3x3-hit sequence with maximum down-force power.

Note: If power is cycled to the Talon, Talon will "remember" if it was last in "Standard Mode" or "Soft Bottom Mode," and will return to that last known mode. However, if it is left in "Rough Water Mode," and power is cycled, it will default to "Standard Mode." This is done to prevent Talon from unnecessarily over-anchoring.

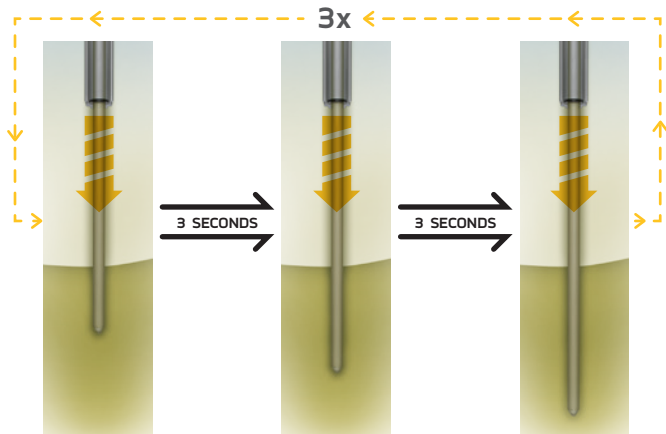

SEQUENCE REPEATED 3 TIMES IN 10 SECOND INTERVALS DURING ROUGH WATER MODE.

DEPLOYMENT NOTIFICATION ALARM

The Deployment Notification Alarm will emit a tone  each time you turn the ignition key to the ON position if the anchor is not retracted. This alarm reminds you that your Talon is still deployed. Taking off with the Talon in the deployed position could cause damage to your anchor or boat which will not be covered by warranty.

NOTE: Deployment Notification Alarm is required to be installed to comply with warranty requirements.

RETRACTION NOTIFICATION ALARM

Your Talon is equipped with a built-in Retraction Notification Alarm to protect the lift motor. If the lift capacity of the motor is exceeded – OR – the motor takes more than 10 seconds to retract, the motor will stop and notify you with a series of three triple beeps (...-...-...) .

The most common reasons for the Retraction Notification Alarm sounding are: 1) because of an extremely soft or muddy bottom, and the spike is deeply buried and cannot retract on its own; or 2) there may be an excessive amount of side load on the spike, generally due to fast moving water currents or wind.

IF THE RETRACTION NOTIFICATION ALARM IS EMITTED, THE FOLLOWING STEPS SHOULD BE TAKEN TO RETRACT THE ANCHOR

Press the UP button  on the remote or control panel. If the anchor does not raise within two attempts:

1. Loosen the spike from the bottom by CAREFULLY shifting the boat back and forth using the main engine power, then attempting to raise the anchor again. This is especially useful if you are fishing in a soft or muddy bottom structure.*
2. Remove any excessive side loads on the anchor as described above. This generally requires backing against the current (or direction of the load) then attempting to retract the anchor again with side loads removed.

***IF THIS IS TYPICAL FOR THE AREAS YOU FISH, WE STRONGLY RECOMMEND USING THE SOFT BOTTOM MODE TO PREVENT OVER-ANCHORING.**

Note: Certain international models may use a different wireless device for Talon controls other than what is shown in these instructions. The instructions for programming and operation of those devices are included in those specific models.

OTHER REASONS FOR THE RETRACTION NOTIFICATION ALARM MAY INCLUDE

1. Battery power is low. This may induce a retraction time greater than 10 seconds.
2. Obstructions on the anchor preventing it from retracting.

In the event the anchor cannot be retracted normally, please refer to page 9 of this booklet for the manual retraction procedure.

REMOVAL AND STORAGE

If needed, your Talon can be easily removed from the Transom Bracket.

TO REMOVE

1. Prior to removal, make sure the Talon is fully retracted, and the power cable is completely free from all routing restraints and fully disconnected from power. This includes any connections made for the Deployment Notification Alarm (green wire).

NOTE: Disconnection from power can be made easier by using the Talon Quick Disconnect Plug accessory, see page 18.

CAUTION: Be sure that the top stop nut assembly is tight BEFORE attempting to remove the Talon from the mounting bracket.

2. Using a 9/16" box end wrench or socket wrench, carefully loosen the four (4) vertical adjustment nuts.

NOTE: DO NOT REMOVE the four (4) vertical adjustment nuts to prevent them from being misplaced. They only need to be loosened to remove the Talon from the mount. Nuts are shown here removed for illustration purposes only.

3. Slide the Talon Assembly up until it clears the mounting straps.
4. Be sure to retighten the vertical adjustment nuts on the mounting straps in the mounting bracket to prevent them from rattling during transport, and to protect the threads.

IMPORTANT: When reinstalling Talon, it is important to check the tension of the four (4) vertical adjustment nuts after their initial use, and periodically thereafter to ensure they maintain their recommended torque of 30 ft lb.

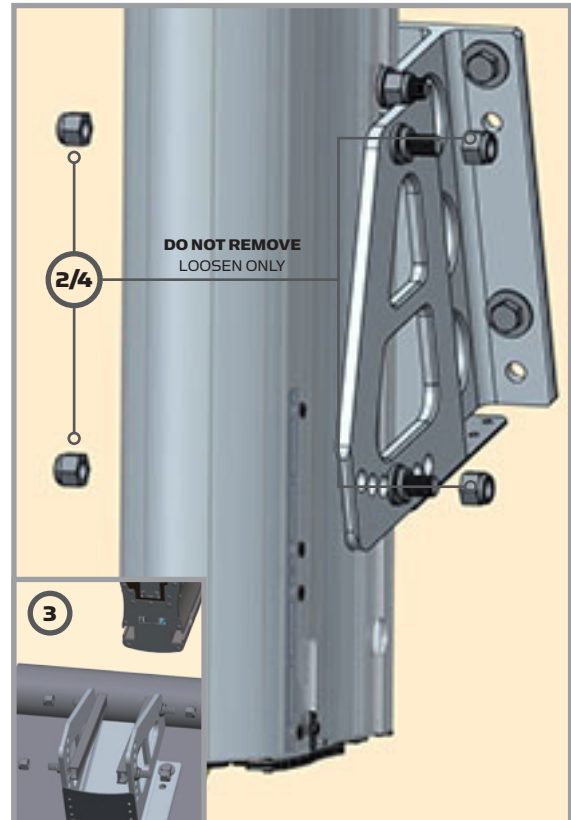

QUICK REMOVAL ACCESSORIES

If you intend to remove or adjust your Talon frequently, you might consider installing the following accessory kits: Quick Release Handle Kit (1810232) and Talon Quick Disconnect Plug (1810240). For accessory information, refer to page 18.

SERVICE AND MAINTENANCE

REMOTE BATTERY REPLACEMENT

1. Make sure hands are clean, dry and static free. Discharge any static electricity by touching a metal object that is grounded.

WARNING: Static electricity can damage the circuit board.

2. With the remote upside down, remove the four (4) case screws.
3. Remove the bottom cover.
4. Carefully remove the old battery from the battery holder and replace with a new one. The battery snaps in and out of the battery holder. Install the new battery with the positive (+) side facing up away from the circuit board. Use a name brand CR2032 lithium coin cell battery.
5. Replace back cover and reinstall case screws. Do not over tighten case screws as this will damage the remote enclosure.

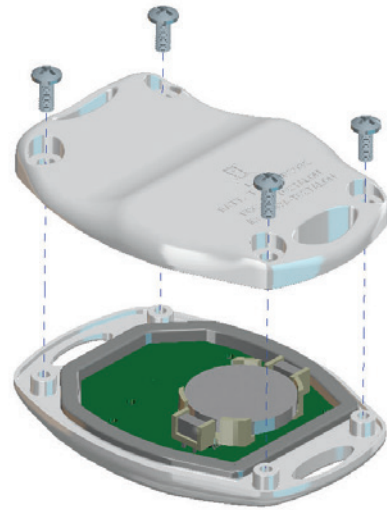

CLEANING THE UNIT

Minn Kota recommends as part of your normal routine, to rinse the Talon to minimize any build up on the anchor. Following one of the rinse practices listed below is recommended after every use.

30 SECOND DEEP WATER RINSE. (RECOMMENDED)

1. Before docking / trailering your boat, enter into water depths that exceed the depth capacity of your Talon in an area free of obstructions.
2. Double click the DOWN button on the remote to auto deploy the Talon to full extension.
3. Place the main engine into gear AT IDLE ONLY.
4. Single click the UP button on the remote.

EXTENDED HOSE RINSE

1. Lay the Talon down and extend fully.
2. For simplicity, we suggest using a Talon Tilt Bracket accessory (part number 1810222). Otherwise, remove the Talon from the mounting bracket and lay down to extend for rinsing.
3. Rinse the sections of the Talon thoroughly while extended.
4. Retract the Talon, and return it to its upright installed position.



REPLACING THE SPIKE

The spike for your Talon comes with a lifetime guarantee. See the warranty section of the manual for further details.

TO REPLACE

Tools Required:

- Pin Punch 1/8"
- Hammer
- Allen Wrench 2mm

1. Extend the spike out so that the second stage begins to exit the bottom of the anchor. This may require removing the anchor from the mounting bracket, and laying the anchor horizontally or on a flat surface.

NOTE: The 12', 10' and 8' Talon Tilt Bracket accessory (part number 1810222) is available to make this process easier. With this accessory, you don't have to remove the Talon from the mount to replace the spike.

2. You will need to remove two (2) retainer pins in order to replace the spike. First remove the spike isolator restrainer pin, and slide the spike isolator out from the bottom of the second stage. Next, remove the spike retainer pin.
3. Remove the spike from the anchor. (You will not need to retain the O-ring from the spike you are replacing. The new spike will include a replacement O-ring.)
4. Place the new spike into position along with the replacement O-ring. When the spike is fully seated into the anchor, the O-ring should be slid up to the face of where the spike is held. Be sure to align the retainer groove on the spike with the retainer pin hole.
5. Slide the spike isolator up the spike and into the second stage. Carefully replace the spike isolator retainer pin.
6. Carefully replace the spike retainer pin, making sure the ends of the pin are recessed on both sides.

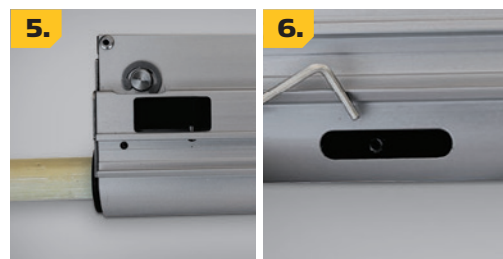
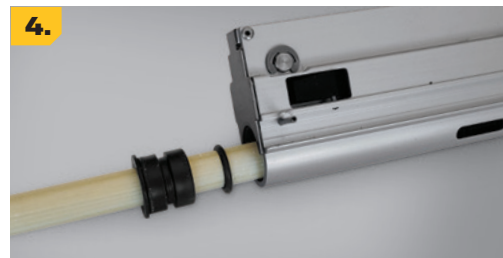
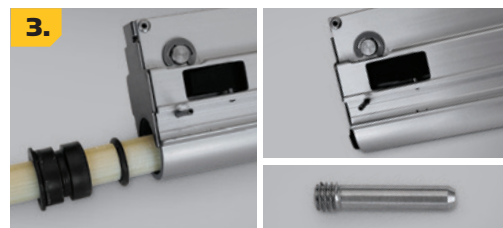

FUSE RESET

To reset the 30A in-line fuse, the following steps should be taken. The 30A fuse is located 6" from the positive battery terminal.

1. Remove the protective housing from the fuse holder, exposing the 30A fuse.
2. Reset the fuse by pushing in the breaker button to engage the fuse.
3. Replace the protective housing on the fuse holder, making sure housing snaps back on to ensure a watertight seal.

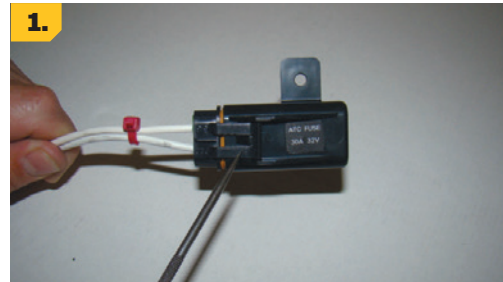

RIGGING ACCESSORIES

ADAPTER BRACKETS

CHOOSING YOUR BRACKET

Selecting the right Talon bracket is as easy as 1-2...well that's it.

JUST ANSWER THESE TWO QUESTIONS TO FIND THE BRACKET YOU NEED

1. Do You Need an Adapter Bracket?

This depends on whether you have a flat or curved transom. If you have a flat transom, we recommend mounting Talon directly to the transom (all hardware is included for this) without an adapter bracket. If you have a curved transom, you'll need an adapter bracket.

2. If You Do Need a Bracket, Which Kind?

There are two types of Talon adapter brackets: Jack Plate and Sandwich-Style.

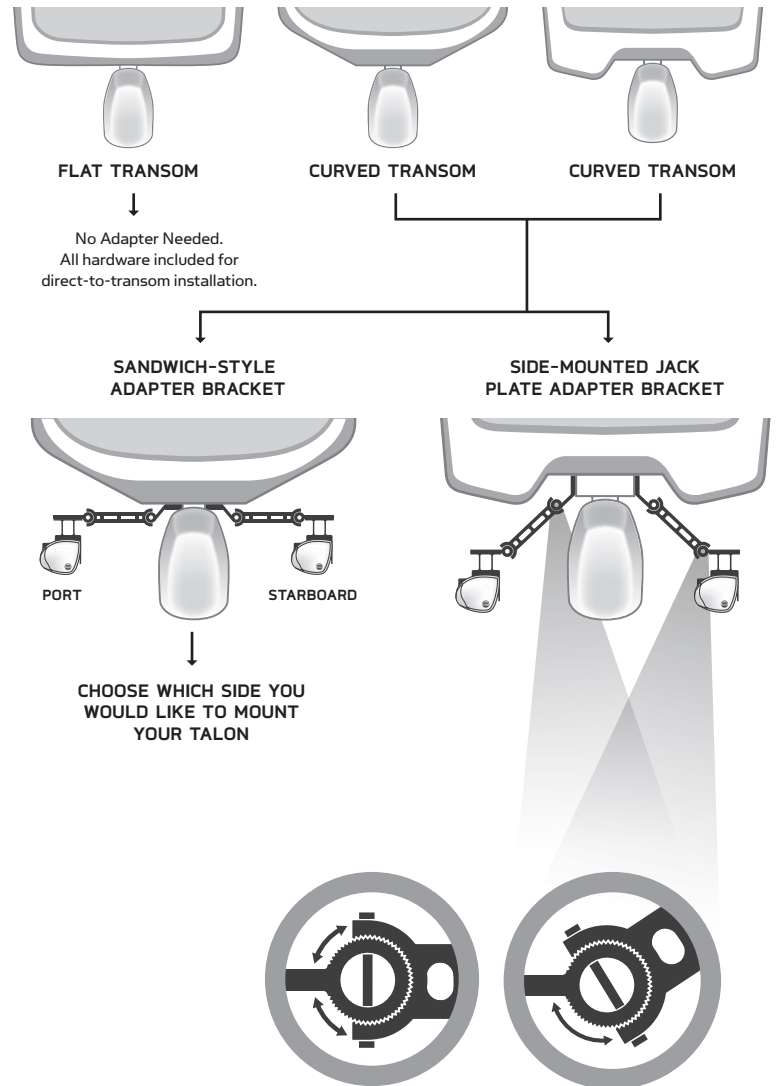

FULLY ADJUSTABLE BRACKETS

With a universal design that fits any transom, our brackets can be adjusted and tweaked to the perfect orientation. And once you've got Talon where you want it, interlocking teeth clamp down to lock it into place.

ADAPTER BRACKETS AND RIGGING ACCESSORIES

ADAPTER BRACKET (1810340)

Mount Talon directly to the side of your jack plate, on either the port or starboard side of your boat.



SANDWICH-STYLE ADAPTER BRACKETS (PORT-1810302 / STARBOARD-1810303)

Mount Talon between your jack plate and transom OR between the outboard and transom, select model for either the port or starboard side of your boat.



HUMMINBIRD 360 IMAGING DUAL MOUNT EXTENSION PLATE* (1810237)

If you want to mount a Talon and a Humminbird 360 Imaging on the same bracket, you'll need our Dual Mount Extension Plate accessory.

* Only compatible with new Universal Modular Adapter Brackets.



SET BACK (1810220)

The Talon 6" set back will give you additional clearance from the transom, such as when installing over top of trim tabs or other accessories.



OTHER TALON MOUNTING ACCESSORIES

ITEM #	DESCRIPTION	SETBACK	PORT/STARBOARD
1810210	Talon Spacer Block Kit**	NA	Both
1810211	Talon BMS Spacer Block Kit – for sandwich mounting between outboard and jack plate	NA	Both
1810212	Talon BMS Side Shim Kit – fills recess gap on side of BMS jack plate; for jack plate mounting	NA	Both

**Note: Some earlier Atlas hydraulic jack plates do not have mounting holes drilled from the factory. Jack plates without mounting holes will have to be drilled and may require part # 1810210 spacer block kit.

ACCESSORIES

QUICK RELEASE HANDLES (1810232)

The Talon Quick Release Handles will allow you to quickly remove your Talon when not in use, and/or adjust the height of Talon without the use of hand tools.



QUICK DISCONNECT PLUG (1810244)

The Talon Quick Disconnect Plug works well with the Quick Release Handles accessory for those who want to be able to easily remove and replace Talon for storage or security.



2 BUTTON REMOTE ACCESSORY

LANYARD INCLUDED (1810250)

A 2 Button replacement remote for single Talon use.



4 BUTTON REMOTE ACCESSORY

LANYARD INCLUDED (1810251)

The Talon 4 Button Remote is available for the avid angler who may choose to install two (2) Talons on their boat. The 4 button remote offers the versatility of individually operating two (2) Talons with a single remote.



TALON TILT BRACKET (1810222)

This marine-grade, anodized aluminum tilt bracket accommodates for low-clearance areas and boat storage. Features adjustable deck support for added stability while tilting.



TALON COVER

(1810239, 1810235)

While trailering, protect your Talon with this durable, UV-resistant, black vinyl cover. Features an all-weather, corrosion-resistant zipper.



TALON FOOT SWITCH (1810256)

This simple wireless switch lets you easily raise and lower the spike. Control up to two (2) Talons (independently or simultaneously) from the waterproof switch, which uses an LED display and features an easy-access battery compartment.

**SECURITY LOCK KIT/ADAPTER BRACKET LOCK** (1810243)

These custom stainless steel locks protect Talon from theft or tampering, and can only be opened with the included unique cut key. Adapter brackets mounted to the jack plate require the use of both sets of accessory locks.

Security Adapter Bracket Lock
Secures jack plate mounting brackets to jack plate.**Security Lock Kit**

Secures Talon unit to quick release bracket OR quick release bracket to adapter bracket/boat transom.

PARTS LIST

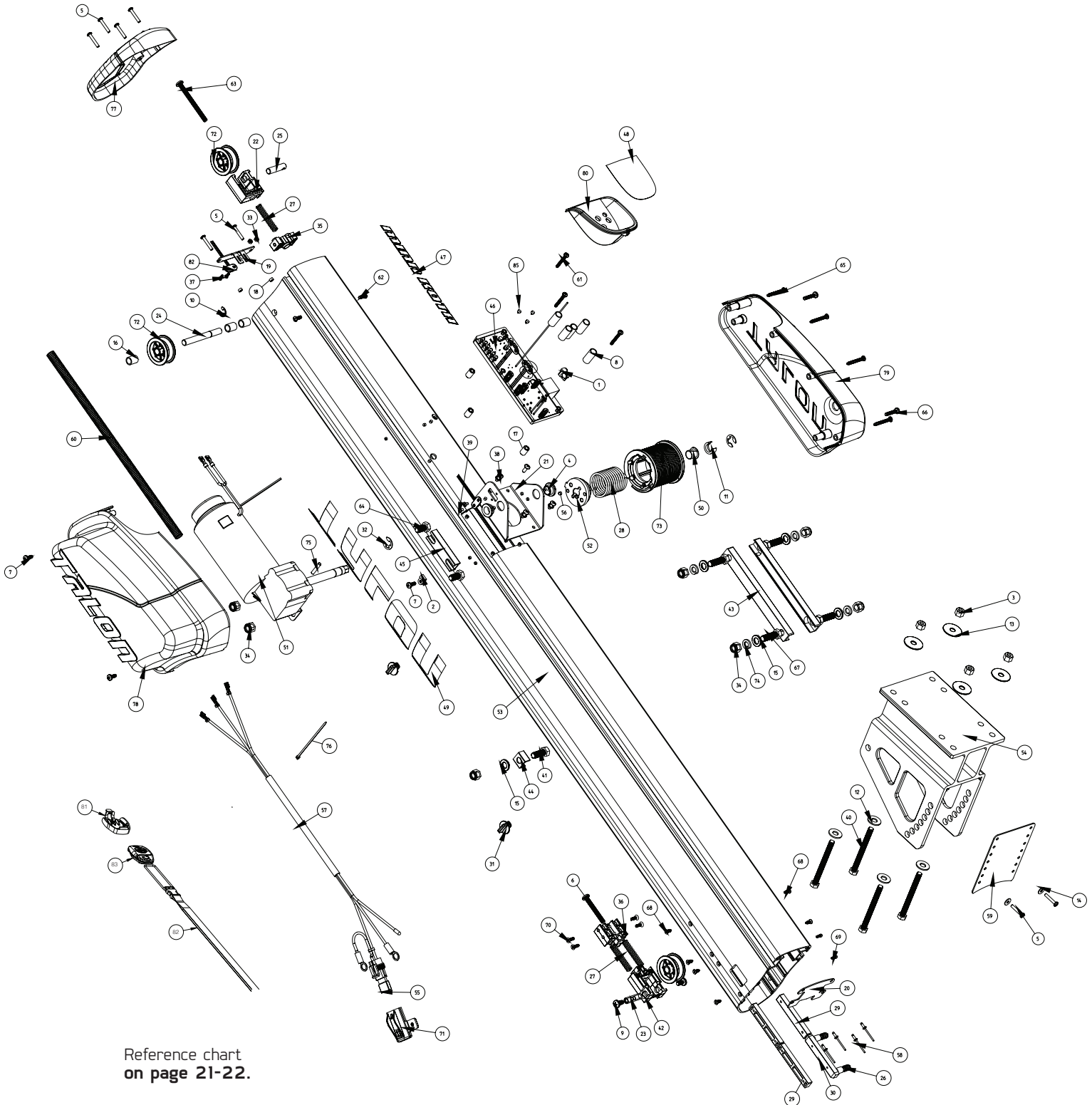

Reference chart
on page 21-22.

ITEM NUMBER	QUANTITY	PART NUMBER(S)	PART NAME
1	2	2040340	SCOTCHLOK CONNECTOR
2	1	2040721	CLAMP CABLE, 3/8"
3	4	2223100	5/16-18 NYLOCK, SS
4	2	2227304	BUSHING-HAT 1/2" SHAFT BRONZE
5	8	2263434	#8-18 X 1 SS PPH
6	1	2263466	SCREW, 1/4-20 X 2" PPH SS/REI
7	3	2303434	SCREW, #8-32 X 5/8 PPMS SS
8	3	2305404	SHRINK TUBE, .374 ID X 1.0"
9	2	2323404	SCREW, 1/4-20 x 1/2" PPH
10	1	2370832	C-CLIP, 3/8 LOW CLEARANCE SS
11	1	2371537	WRAP DRUM SPACER
12	4	2371749	5/16" FLAT WASHER, SS
13	4	2371752	WASHER, 5/16 FENDER
14	2	2371754	#8 WASHER, 1/2 OD, SS
15	5	2371758	3/8 HD FLAT WASHER, SS
16	3	2371765	PULLEY SPACER, SHORT
17	3	2371767	CONTROL BOARD SPACER, T2
18	2	2371780	SPACER, #8 X .125"
19	1	2371909	SENSOR BRACKET, TALON2
20	1	2371957	WATER GUARD, MAIN TALON2
21	1	2371992	WRAP DRUM MOUNT, TALON2
22	1	2372350	TENSIONER BLOCK
23	1	2372647	PIN EXTENSION TENSIONER
24	1	2372663	BOTTOM PULLEY PIN, T2
25	1	2372664	TENSIONER-PULLEY-PIN
26	2	2372740	SPRING, GIB TENSION
27	3	2372742	SPRING, PISTON
28	1	2372746	SPRING, TORSION - WRAP DRUM, TALON2
29	3	2372820	SLIDE GIB, LOWER
30	1	2372827	SLIDE GIB, FLOATING .089
31	2	2372930	CORD RETAINER
32	2	2373005	E-RING EXTERNAL SS .500
33	2	2373106	NUT #4-40 NYLOK, SS
34	7	2373138	3/8-24 MYLOK NUT, SS
35	1	2373201	TENSIONER STOP
36	1	2373202	EXTENSION TENSIONER STOP
37	2	2373439	SCREW #4 X 5/8 PPMS SS
38	4	2373481	SCREW #10-32 X 1/2 SEMS PPH SS
39	2	2373485	#6-32 X 1/4" TYPE F PPH SS
40	4	2373525	5/16-18 X 3-1/2 HHCS SS
41	1	2373529	3/8-16 X 1" HHCS SS
42	1	2373630	EXTENSION TENSIONER SLIDE
43	2	2373815	TALON MOUNTING TRAP, T2
44	1	2373816	TALON STOP BOLT EXTRUSION
45	1	2373820	TALON 2, MOTOR STRAP
46	1	2374169	PCB-ASM, TALON 2
47	1	2375687	DECAL, MINNKOTA FRONT, TALON 10'/12'
		2375892	DECAL, MINNKOTA FRONT, TALON 10'/12" WHITE
		2375884	DECAL, MINNKOTA FRONT, TALON 8'
		2375886	DECAL, MINNKOTA FRONT, TALON 8' CAMO
		2375891	DECAL, MINNKOTA FRONT, TALON 8' WHITE
48	1	2375739	DECAL, COVER-BEZEL - 12" BLACK
		2375758	DECAL, COVER-BEZEL - 10" BLACK
		2375883	DECAL, COVER-BEZEL - 8" BLACK
		2375797	DECAL, COVER-BEZEL - 12" WHITE
		2375759	DECAL, COVER-BEZEL - 10" WHITE
		2375885	DECAL, COVER-BEZEL - 8" WHITE
49	1	2375880	DECAL, LARGE TALON LOGO
		2375893	DECAL, LARGE TALON LOGO WHITE
50	1	2376012	BEARING, WRAP DRUM
51	1	2377814	SEALED MOTOR, TALON 2
52	1	2377906	HUB, WRAP DRUM, ALUMINUM

ITEM NUMBER	QUANTITY	PART NUMBER(S)	PART NAME
53	1	2378070	OUTER COLOR EXTRUSION - 8' CLEAR
		2378071	OUTER COLOR EXTRUSION - 8' BLACK
		2378072	OUTER COLOR EXTRUSION - 8' BLUE
		2378073	OUTER COLOR EXTRUSION - 8' RED
		2378074	OUTER COLOR EXTRUSION - 8' CAMO
		2378075	OUTER COLOR EXTRUSION - 8' WHITE
		2378060	OUTER COLOR EXTRUSION - 10' CLEAR
		2378061	OUTER COLOR EXTRUSION - 10' BLACK
		2378062	OUTER COLOR EXTRUSION - 10' BLUE
		2378063	OUTER COLOR EXTRUSION - 10' RED
		2378064	OUTER COLOR EXTRUSION - 10' CAMO
		2378084	OUTER COLOR EXTRUSION - 10' WHITE
		2378065	OUTER COLOR EXTRUSION - 12' CLEAR
		2378066	OUTER COLOR EXTRUSION - 12' BLACK
		2378067	OUTER COLOR EXTRUSION - 12' BLUE
2378068	OUTER COLOR EXTRUSION - 12' RED		
2378069	OUTER COLOR EXTRUSION - 12' CAMO		
2378089	OUTER COLOR EXTRUSION - 12' WHITE		
54	1	2378031	EXTRUSION, MOUNTING BRACKET
		2378034	EXTRUSION, MOUNTING BRACKET-CAMO
55	1	2378231	RESETTABLE FUSE - 30A
56	2	2378448	.187 X .125 MAGNET
57	1	2378514	POWER CORD, 14AWG, 3 CONDUCTOR
58	4	2378601	POP RIVET, 1/8" SS
59	1	2378809	WATER SHIELD, DEFLECTOR TALON 2
60	1	2378850	WIRE LOOM 3/8"
61	3	2383444	#8-32 X 1-1/4" PPH MACHINE SS
62	2	2383446	#8-16 X 1/2" PLASTITE SCREW SS
63	1	2383451	SCREW, 1/4-20 X 2.75" PPH SS
64	2	2383456	3/8-24 X .75" HHCS SS
65	4	2383457	SCREW #8-16 X 1.5 PLASTITE SS
66	2	2383458	SCREW #8-32 X 1.0 PPH SS
67	4	2383459	3/8-24 X 1.25 HHCS SS
68	6	2383461	SCREW, #8 X .437 SS HI-LO
69	2	2383468	SCREW #4-40 X 5/16 SHCS SS
70	4	2383474	SCREW, #8-16 X 1/2" PFH, SS
71	1	2990279	FUSE CAP W DECAL
72	3	2992366	PULLEY W BUSHING, LARGE IDLER
73	1	2997920	WRAP DRUM, MODULAR ASM TALON 2
74	4	3391706	WASHER 3/8 SS
75	1	3392640	PIN, DRIVESHAFT
76	1	9950433	TIE WRAP, 4"
77	1	2370285	COVER TALON 2, BLACK
		2370286	COVER TALON 2, WHITE
		2370284	COVER TALON 2, CAMO
78	1	2370293	HOUSING LEFT, TALON 2 BLACK
		2370294	HOUSING LEFT, TALON 2 WHITE
		2370292	HOUSING LEFT, TALON 2 CAMO
79	1	2370297	HOUSING RIGHT, TALON 2 BLACK
		2370298	HOUSING RIGHT, TALON 2 WHITE
		2370299	HOUSING RIGHT, TALON 2 CAMO
80	1	2378835	BEZEL HOUSING, TALON 2 BLACK
		2378836	BEZEL HOUSING, TALON 2 WHITE
		2378837	BEZEL HOUSING, TALON 2 CAMO
81	1	2371883	REMOTE DASH HOLDER
82	1	2370818	LANYARD, REMOTE
83	2	2994044	REMOTE ASSEMBLY
84	1	2994903	BAG ASSEMBLY, MOUNTING HARDWARE
85	3	2373715	BUTTON CONTROL BOARD, TALON 2

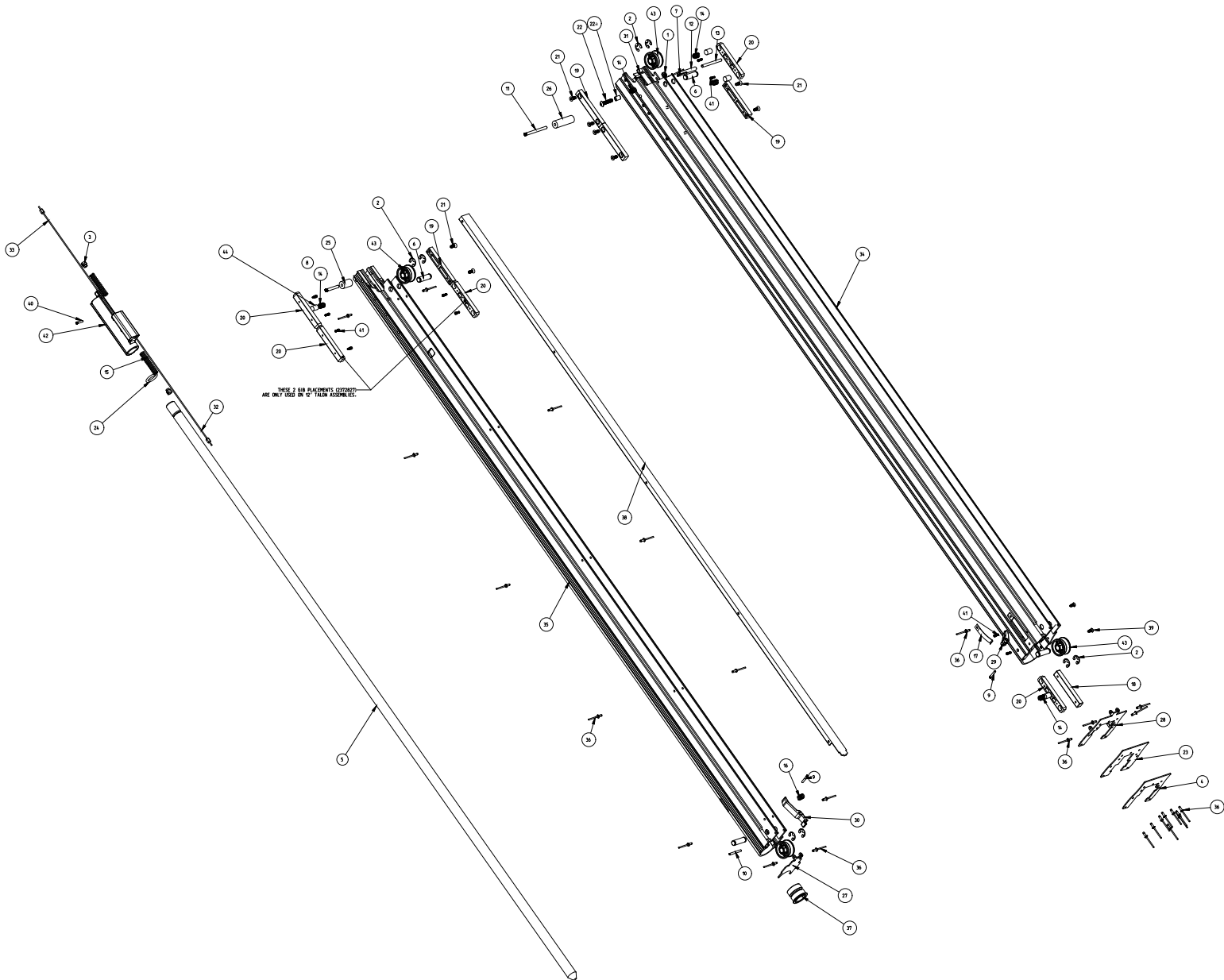

Reference chart
on page 24.

ITEM NUMBER	QUANTITY	PART NUMBER(S)	PART NAME
1	1	2333101	NUT, 10-24 NYLOK 18-8 SS
2	8	2370832	C-CLIP, 3/8 LOW CLEARANCE SS
3	2	2370850	CABLE-KEEPER
4	1	2371981	WIPER, RETAINER
5	1	2372027 2372007 2372008	SPIKE, .75 X 40.4", 8' SPIKE, .75 X 48.3", 10' SPIKE, .75" x 56.4", 12'
6	4	2372316	SHAFT, IDLER
7	1	2372643	PIN, SPRING 1/8 X 1.0 SS
8	1	2372645	PIN-DOWEL 3/16" X 1.5 SS TALON 2
9	2	2372653	PIN KNURLED 1/8"
10	1	2372654	PIN, SPRING 1/8 X 1-1/4 SS
11	1	2372659	PIN DOWEL 3/16 X 2.5 SS TALON 2
12	1	2372668	3RD STAGE SUPPORT PIN
13	1	2372669	3RD STAGE SUPPORT DOWEL
14	5	2372740	SPRING, GIB TENSION
15	2	2372742	SPRING, PISTON
16	1	2372743	SPRING, .36 X .5
17	1	2372748	SPRING-LATCH-3RD
18	1	2372820	SLIDE GIB, LOWER
19	4	2372828	SLIDE GIB, UPPER
20	5	2372827	SLIDE GIB, FLOATING .089
21	8	2323409	SCREW, #10-24 X 3/8" PPH MACHINE
22	1	2383469	SCREW, #10-24 X .750, SS, BHCS
22a	1	2371781	SPACER, LATCH, SS
23	1	2374618	WIPER, 2ND STAGE
24	1	2374632	O-RING, 3/4" ID X .125
25	1	2375416	INSULATOR, 1/4" STOP PIN
26	1	2375418	2ND STAGE INSULATOR, 1/4" STOP PIN TALON 2
27	1	2376440	SHIELD-DEBRIS, 2ND STAGE
28	1	2376441	DEBRIS-SHIELD-2ND STAGE WIPER
29	1	2377201	3RD STAGE LATCH
30	1	2377205	LATCH SECOND STAGE
31	1	2377220	CLIP-3RD STAGE
32	1	2377500 2377501 2377503	CABLE ASSY, 2 MM, EXTEND 12' CABLE ASSY, 2MM, EXTEND 10' CABLE ASSY, 2MM, EXTEND 8'
33	1	2377502 2377504	CABLE ASSY, 2 MM RETRACT 10'/12' CABLE ASSY, 2 MM RETRACT 8'
34	1	2378027 2378026 2378050	3RD STAGE, MACHINED 12' 3RD STAGE, MACHINED 10' 3RD STAGE, MACHINED 8'
35	1	2378029 2378028 2378055	2ND STAGE, MACHINED 12' 2ND STAGE, MACHINED 10' 2ND STAGE, MACHINED 8'
36	31	2378601	POP RIVET, 1/8" SS
37	1	2378825	ISOLATOR, SPIKE
38	1	2378824 2378823 2378826	DEBRIS-CHANNEL 12' DEBRIS-CHANNEL 10' DEBRIS-CHANNEL 8'
39	2	2383461	SCREW, #8 X .437 SS HI-LO
40	1	2383464	SETSCREW M4-.07 X .70" SS
41	10	2383468	SHCS 4-40 X 5/16 SS
42	1	2991509	PISTON W/ MAGNETS ASM
43	4	2992365	SM IDLER PULLEY W BUSHING

COMPLIANCE STATEMENTS

ENVIRONMENTAL COMPLIANCE STATEMENT

It is the intention of Johnson Outdoors Marine Electronics, Inc. to be a responsible corporate citizen, operating in compliance with known and applicable environmental regulations, and a good neighbor in the communities where we make or sell our products.

WEEE DIRECTIVE

EU Directive 2002/96/EC “Waste of Electrical and Electronic Equipment Directive (WEEE)” impacts most distributors, sellers and manufacturers of consumer electronics in the European Union. The WEEE Directive requires the producer of consumer electronics to take responsibility for the management of waste from their products to achieve environmentally responsible disposal during the product life cycle. WEEE compliance may not be required in your location for electrical and electronic equipment (EEE), nor may it be required for EEE designed and intended as fixed or temporary installation in transportation vehicles such as automobiles, aircraft and boats. In some European Union member states, these vehicles are considered outside of the scope of the Directive, and EEE for those applications can be considered excluded from the WEEE Directive requirement.

This symbol (WEEE wheelie bin) on product indicates the product must not be disposed of with other household refuse. It must be disposed of and collected for recycling and recovery of waste EEE. Johnson Outdoors Marine Electronics, Inc. will mark all EEE products in accordance with the WEEE Directive. It is our goal to comply in the collection, treatment, recovery and environmentally sound disposal of those products; however, these requirements do vary within European Union member states. For more information about where you should dispose of your waste equipment for recycling and recovery and/or your European Union member state requirements, please contact your dealer or distributor from which your product was purchased.

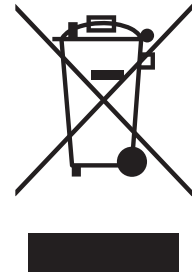

WARNING:

This product contains chemical(s) known to the state of California to cause cancer and/or reproductive toxicity.

RADIO OPERATION:

- Frequency band: 433.92 MHz
- Maximum RF power transmitted: +7 dBm

FCC COMPLIANCE

This device complies with Part 15 of the FCC rules.

Operation is subject to the following two conditions:

1. This device may not cause harmful interference.
2. This device must accept any interference that may be received, including interference that may cause undesired operation.

Changes or modifications not expressly approved by Johnson Outdoors Marine Electronics, Inc. could void the user's authority to operate this equipment.

This product meets the applicable Industry Canada technical specifications/Le présent matériel est conforme aux spécifications techniques applicables d'Industrie Canada.

Note: This equipment has been tested and found to comply with the limits for a Class B digital device, pursuant to part 15 of the FCC Rules. These limits are designed to provide reasonable protection against harmful interference in a residential installation. This equipment generates, uses and can radiate radio frequency energy and, if not installed and used in accordance with the instructions, may cause harmful interference to radio communications. However, there is no guarantee that interference will not occur in a particular installation. **If this equipment does cause harmful interference to radio or television reception, which can be determined by turning the equipment off and on, the user is encouraged to try to correct the interference by one or more of the following measures:**

- Reorient or relocate the receiving antenna.
- Increase the separation between the equipment and receiver.
- Connect the equipment into an outlet on a circuit different from that to which the receiver is connected.
- Consult the dealer or an experienced radio/TV technician for help.

Transmitter Model: 2994044

- IC: 4397A-T62TALON
- FCC ID: T62TALON
- Carrier Frequency: 433.92MHz
- RF output power: 87.07 dBuV/m measured at 3m yield EIRP of -8 dBm (.15 milliWatts)

SHALLOW WATER ANCHOR

TALON



minnkotamotors.com

MINN KOTA CONSUMER
& TECHNICAL SERVICE.
P.O. Box 8129
Mankato, MN 56002

121 Power Drive
Mankato, MN 56001
Phone (800) 227-6433
Fax (800) 527-4464

